

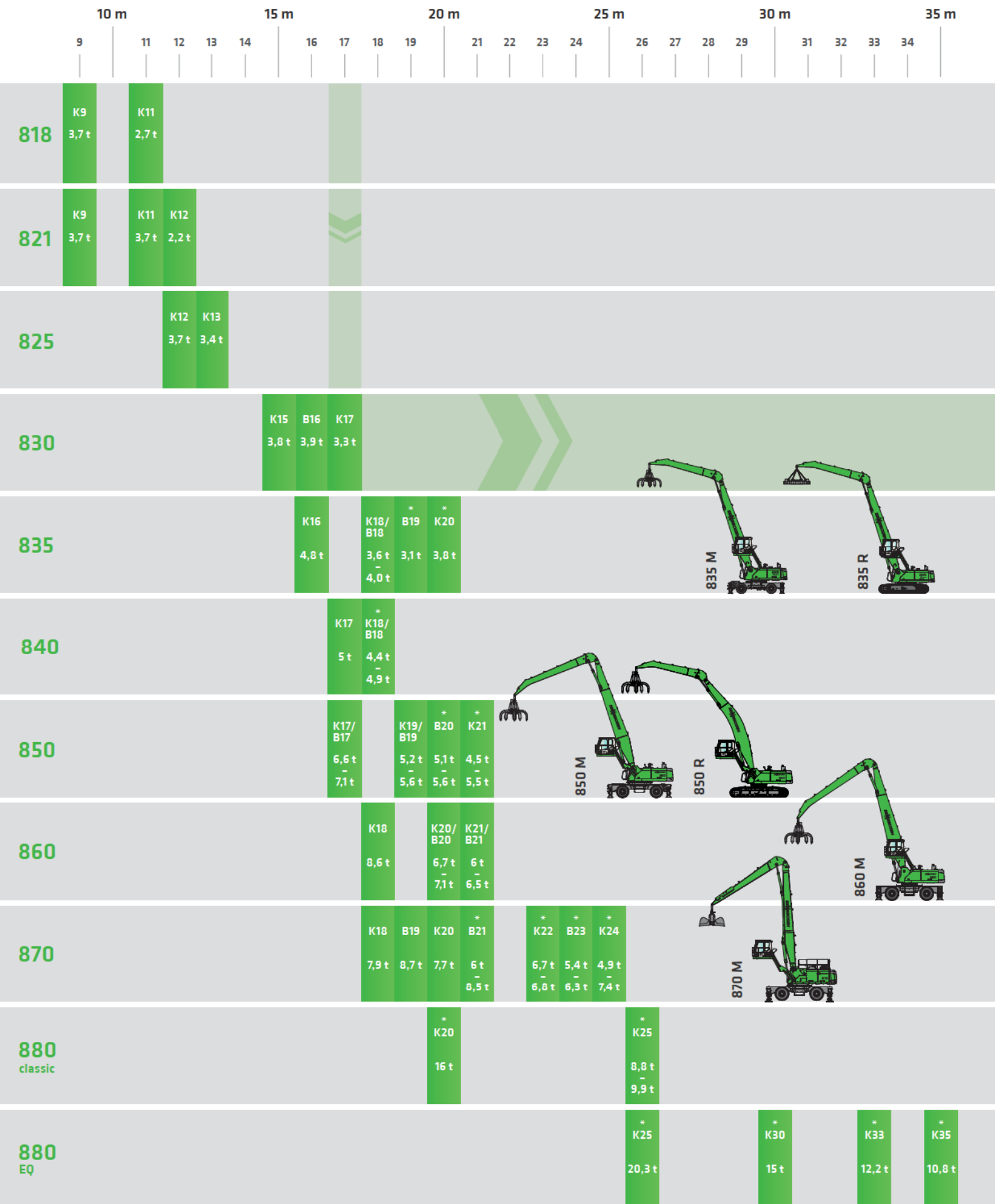

Schrott/Stahlwerke *Scrap Metal/Steel Mills*

Materialumschlag-Maschinen
Material Handling Machines

SENEBOGEN



Sortiment

product range



16

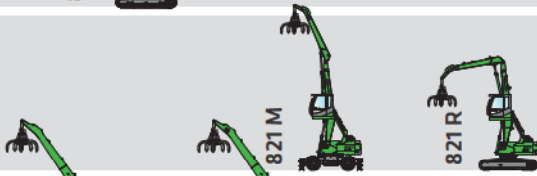

18

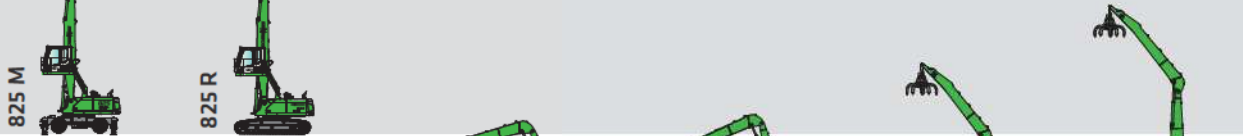

22

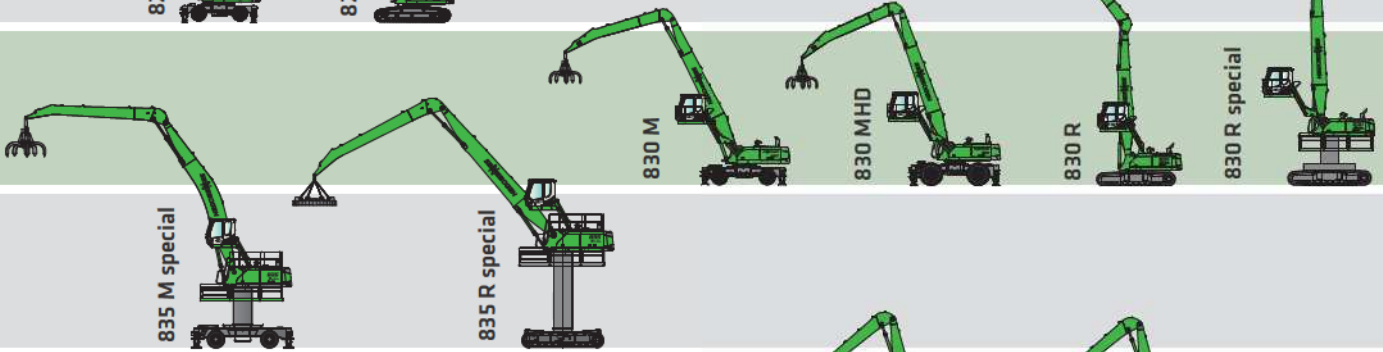

26

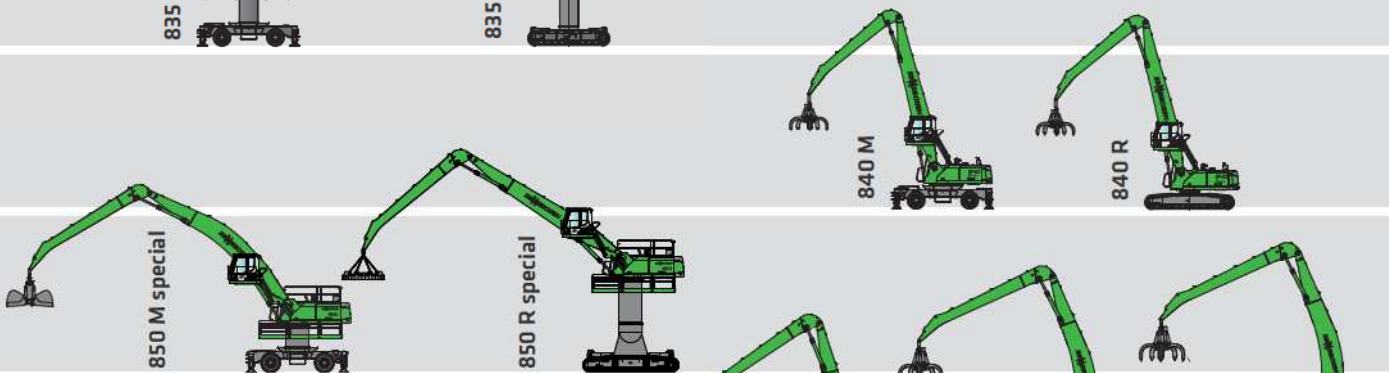

30

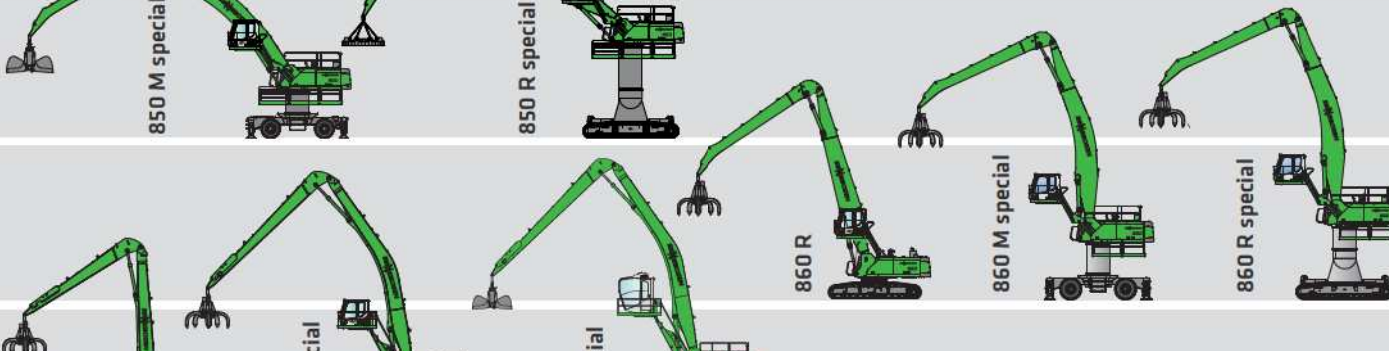

34

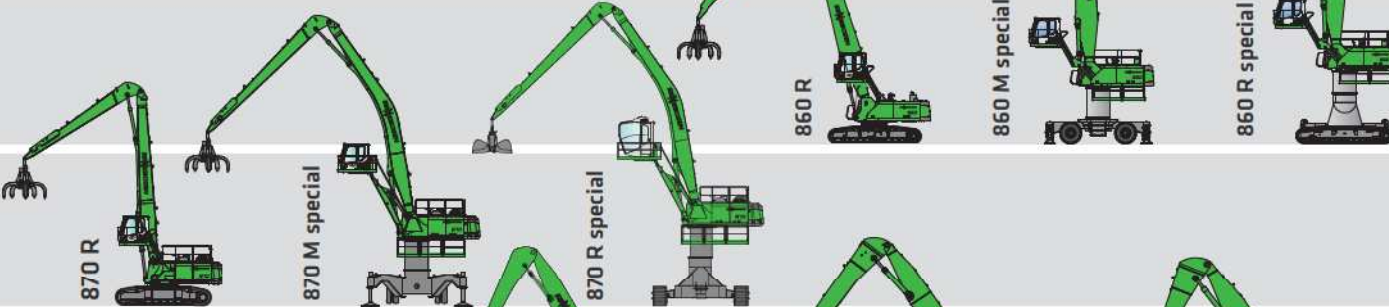

38

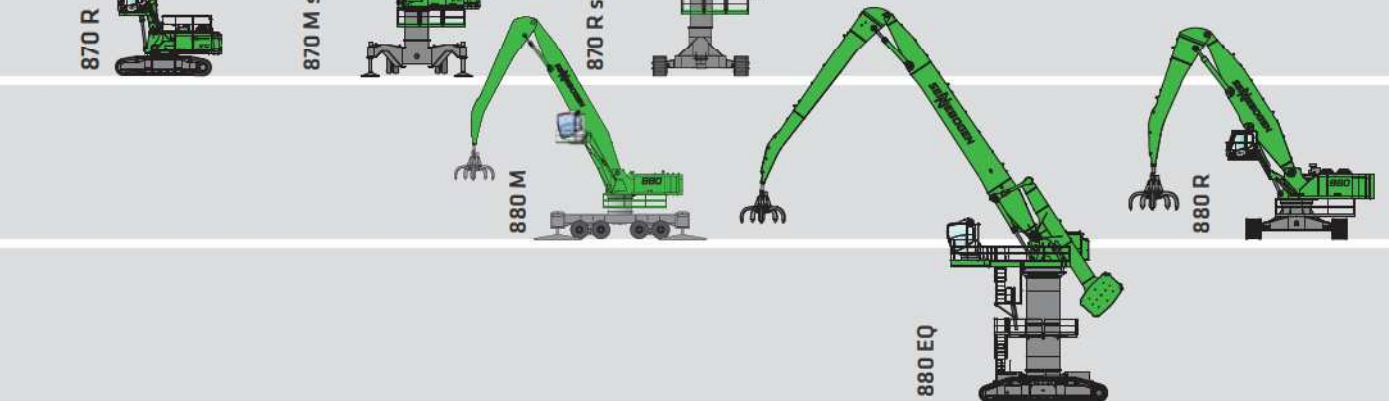

42

44

50

52

Wir lieben einfache, robuste Technik.
We love simple, robust engineering.

» GO FOR GREEN

Wir erfüllen anspruchsvollste Aufgaben. Unser Motto GO FOR GREEN steht dafür, sowohl ökonomische als auch ökologische Anforderungen in beste Lösungen umzusetzen. Wir haben diese Philosophie in acht Grundwerten für unsere Produkte festgeschrieben:

1. **Investitionssicher** – durch robuste Technik mit einer langen Lebensdauer
2. **Maßgeschneidert** – durch modulare Konstruktionen und kundenspezifische Ausführungen
3. **Verfügbar** – durch beherrschbare Technik statt Over-Engineering
4. **Zuverlässig** – durch Fokus auf Funktion und jederzeit abrufbare Leistung
5. **Vorsprung durch Innovation** – durch sichtbar bessere Lösungen und absolute Konzentration auf Materialumschlag (wir bauen keine Erdbaubagger)
6. **Nachhaltig denken** – clever investieren. Gesamtkosten senken
7. **Wertbeständig** – durch Qualität „Made in Germany“
8. **Zukunftsorientiert** – durch die Option elektrohydraulischer Antriebskonzepte – emissionsfrei, geräuscharm – unvergleichlich niedrige Betriebskosten

We fulfil even the most demanding of tasks. Our motto “GO FOR GREEN” stands for our commitment to implementing both economical and ecological requirements in optimal solutions. We have formulated this philosophy in eight basic values for our products:

1. **Safe investment** – through robust technology with a long service life
2. **Tailored** – through modular constructions and customer-specific designs
3. **Available** – with easy to handle technology instead of over-engineering
4. **Reliable** – with our focus on function and performance available at any time
5. **Progress through innovation** – with visibly better solutions and the total concentration on material handling (we do not design and build earthmoving excavators)
6. **Sustainable approach** – clever investment. Overall cost reductions
7. **Stable value** – through quality “Made in Germany”
8. **Future-oriented** – with the option of electro-hydraulic drive concepts – emission-free, low-noise – unbeatable low life cycle costs



A green SENNEBOGEN 830 mobile crane is positioned on a concrete platform at a scrap metal recycling facility. The crane's long, articulated boom extends upwards and to the left, with the brand name 'SENNEBOGEN' clearly visible in white lettering. The crane's body is white and green, with the number '830' and the 'Sennebogen' logo on the side. The background shows a large pile of scrap metal, including twisted rebar and other debris, under a blue sky with scattered white clouds. In the top left corner, there is a decorative graphic of three white chevrons pointing right, overlaid on a semi-transparent blue background.

**Tausende Maschinen rund um die Uhr
weltweit im schweren Materialumschlag**
*Thousands of machines working 24/7
worldwide in heavy duty material handling*

60 Jahre Historie: Erfahrung und Know-how

60 years of history: Experience and Know-how

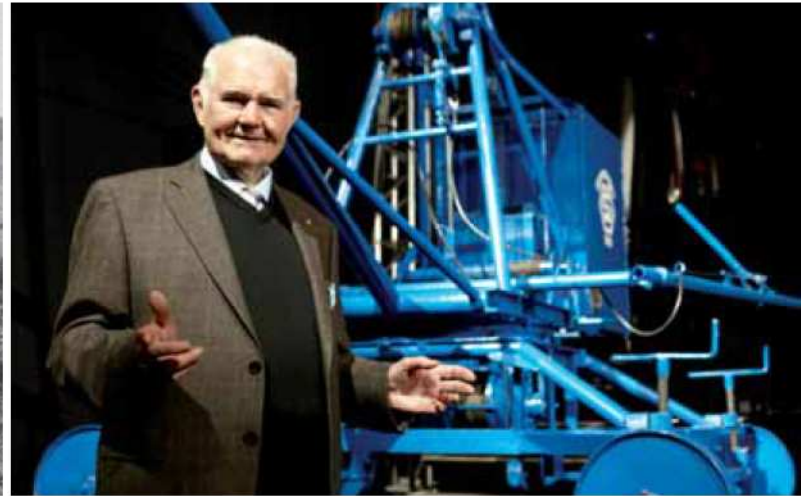
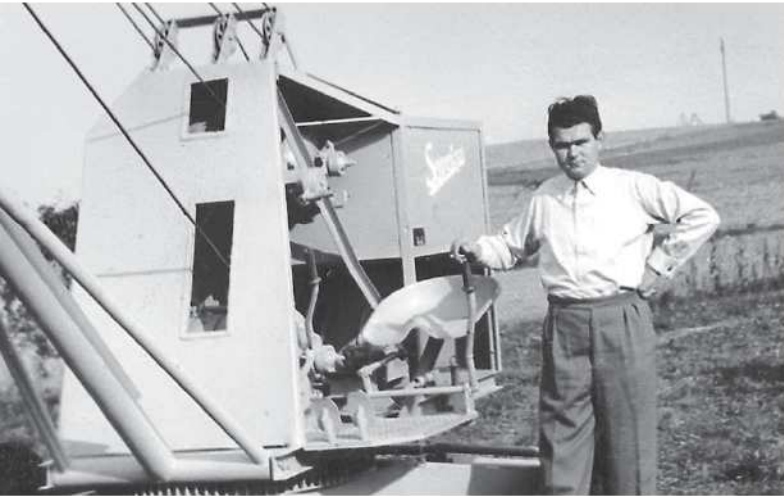

Seit der Firmengründung 1952 durch Erich Sennebogen schreiben wir erfolgreich Geschichte in der Hebe- und Umschlagtechnik und gestalten die Entwicklung des Marktes aktiv und innovativ mit.

Since the company was founded by Erich Sennebogen in 1952, we have been successfully making history in lifting and material handling technology and have been playing an active and innovative role in the development of the market.



1962

SENNEBOGEN entwickelt den S833 für den Einsatz auf dem Schrottplatz mit einer erhöhten Fahrerkabine.
SENNEBOGEN develops the S833 for use on the scrap yard with an elevated driver's cab.



1968

Mit dem S517 kommt eine moderne mobile Umschlagmaschine auf den Markt – mit einer neuartigen Kunststoff-Fahrerkabine.
A modern mobile material handling machine enters the market in the form of the S517 – complete with an innovative driver's cab made from plastic.



1980

Die optional mit Raupenunterwagen gebauten Geräte eignen sich auch für schwierige Böden.
The machines optionally available with crawler under-carriage are suitable for challenging ground conditions.



1982



1990

Kundenspezifische Lösungen – z. B. mit Pylon und Raupenunterwagen beim SR 28 – gehören seit vielen Jahrzehnten zum SENNEBOGEN-Angebot.
Customer-specific solutions – e.g. with pylon and crawler undercarriage for the SR 28 – have been part of the SENNEBOGEN range for decades.



1992

Mobile Maschinen mit hochfahrbarer Kabine – hier beim SM 20 – bieten seit jeher einen besseren Überblick im modernen Materialumschlag.
Mobile machines with elevating cab – shown here with the SM 20 – have been providing a better overview in modern material handling for years.

100 % Familienunternehmen – Kontinuität und Stabilität

100 % family-owned enterprise - continuity and stability



Über Generationen mit Leidenschaft engagiert: Erich Sennebogen sen., Erich Sennebogen jun., Walter Sennebogen, Anton Sennebogen (v.l.n.r.)

Passionate engagement for generations: Erich Sennebogen sen., Erich Sennebogen jun., Walter Sennebogen, Anton Sennebogen (from left to right)



1974

Der S1018 für eine typische Schrottplatz-Applikation – stationär betrieben mit stabilem Gittermastausleger und großen Reichweiten.

The S1018 is launched for typical scrap yard applications – stationary operation with a stable lattice mast boom and large ranges.



1976



1984

Die schweren Schrottscheren gehören zu den vielfältigen Anbaugeräten, die betrieben werden können.

The heavy scrap metal shears are just one of the many attachments which can be operated.



1988

Forderungen nach großen Reichweiten mit hydraulischen Maschinen erfüllt SENNEBOGEN mit dem 526.

SENNEBOGEN responds to demand for large reach capacities in hydraulic machines with the 526.



1996

Mit der **Green Line** kam eine neue Generation von Materialumschlagmaschinen auf den Markt, die die Standards auf dem Markt höher gesetzt hat: Fokus 100 % Materialumschlag.

*A new generation of material handling machines was launched on the market with the **Green Line** range, which has raised the standards in the industry: Focus 100 % material handling.*



1998

Diesel oder Elektro: Effektive Antriebe

Diesel or Electro: Effective drives

Höchste Umschlagleistung

Highest material handling performance

- Speziell auf den Hochleistungs-Materialumschlag ausgelegte Maschine, für maximale Leistung, hohe Zuverlässigkeit und Sicherheit
- *Material handling machine especially designed for highest performance, maximum capacity, high reliability and safety*



Moderne Dieselmotore

Modern diesel engines



- Ausgelegt für industrielle Umschlagmaschinen
- Hervorragende Drehmomentwerte
- Emissionsarm, geringer Verbrauch
- Leerlaufautomatik und Eco-Mode
- Wartungsarm, lange Serviceintervalle
- Weltweiter Service in Ihrer Nähe
- *Designed for industrial material handlers*
- *Excellent torque values*
- *Minimal emissions, low consumption*
- *Idling automatic and Eco-Mode*
- *Low maintenance, long service intervals*
- *Worldwide service nearby*

Elektrohydraulische Antriebe

Electro-hydraulic drives



- Niedrigste Betriebskosten
- Sehr geräuscharmes und quasi vibrationsfreies Arbeiten
- Lange Lebensdauer hydraulischer Komponenten durch pulsationsfreie Antriebe
- Umweltschonend: emissionsfrei
- Für jede SENNEBOGEN-Maschine erhältlich
- *Lowest operating costs*
- *Very quiet and virtually vibration-free operation*
- *Long service life of hydraulic components by pulsation-free drives*
- *Environmental friendly: No emissions*
- *For every type of SENNEBOGEN machine available*

Hydraulische Antriebe

Hydraulic drives



- Hochwertige Antriebskomponenten: Axialkolbenverstellpumpen, Zahnradpumpen, Verteilergetriebe
- Effektive Bedarfsstromsteuerung – fördert nur die erforderliche Ölmenge
- *High-quality drive components: Axial displacement piston pumps, gear pumps, gearboxes*
- *Effective flow on demand control – pumps supply only the required oil flow*

Zuverlässige Elektrik, Hydraulik, Kühlertechnik

Reliable electrics, hydraulics, cooling system



Zuverlässige Steuerung & Elektrik

Reliable controls & electrical systems

- Vermeidung von Elektronik
- Zuverlässige elektrische Komponenten
- Beherrschbare Technik sorgt für hohe Verfügbarkeit
- Schnelle Fehlerdiagnose und einfache Wartung
- Preisgünstiger Service
- *Reliable electrical components*
- *Controllable technology provides high availability*
- *Quick trouble-shooting and easy maintenance*
- *Affordable low cost service*

Hydrauliksystem

Hydraulic system

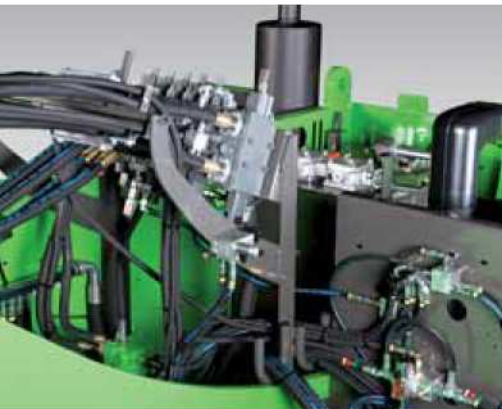

- Beste Wirkungsgrade – große Strömungsquerschnitte, optimierte Schlauchführung
- HydroClean-Filter schützt die Hydraulikkomponenten, lange Lebensdauer
- *Best efficiency – large flow cross-sections, optimized hose arrangement/guidance*
- *Hydro-clean filter protects the hydraulic components, long life time*

Einbau Motor/Lüfterantrieb

Motor installation/fan drive



- Übersichtliche und servicefreundliche Anordnung der Komponenten, längseingebauter Motor
- Thermostatisch geregelte Lüfterantriebe – energiesparend, spürbare Reduktion der Geräuscentwicklung, schnelle Aufheizung im Anlauf für optimale Betriebstemperatur
- *Clear and service-friendly arrangement of all components, longitudinally-mounted engine*
- *Thermostatically controlled fan drives – energy saving, significant reduction of noise, fast start-up heating to the optimum operating temperature*

Kühlsystem

Cooling system



- Groß dimensionierte Kühler für einen problemlosen Einsatz bei hohen Umgebungstemperaturen
- 3-Kreis-Kühlsystem: Side-by-Side-Anordnung für Ladeluft, Wasser- und Ölkühlung; einfache Reinigung
- Gesunde und gleichbleibende Temperaturen für lange Lebensdauer der Komponenten
- *Large cooler for smooth operation even at high ambient temperatures*
- *3-circuit cooling system at side-by-side assembly for charge air, water and oil cooling, easy cleaning*
- *Right and consistent temperatures for long life of the components*

Unterwagen: Ihre Heavy Duty Basis

Lower Carriage: Your heavy duty base

Modulare Unterwagenlösungen

Modular undercarriage solutions

- Mobilunterwagen: verschiedene Bereifungen
- Raupenunterwagen für schwieriges Gelände
- Stationäres Untergestell
- Schienenunterwagen: individuell projektiert
- Portalunterwagen: individuell projektiert
- optional mit Pylon erhöht
- *Mobile undercarriage: different tire options*
- *Crawler undercarriage for difficult terrain*
- *Stationary underframe*
- *Rail undercarriage: configured individually*
- *Portal undercarriage: configured individually*
- *Optional heightened with pylon*



Dauerfeste Mechanik

Fatigue endurable mechanics

Unterwagen: Die stabile Basis

Undercarriage: The stable base

Abstützung/Zentralschmierung

Outriggers/central lubrication

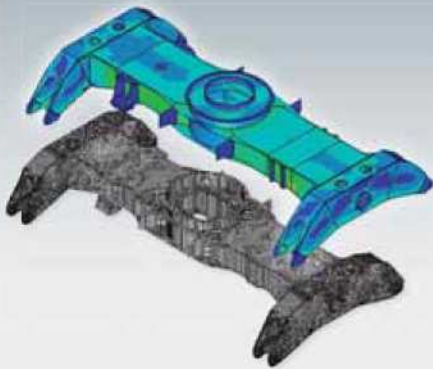

- Hoch beanspruchte Bauteile mit modernen Finite Elemente Berechnungsprogrammen ausgelegt und optimiert
- Große Rahmenquerschnitte, optimiert auf Dauerfestigkeit und geringe Spannungen
- Hochfeste Materialien an den hoch belasteten Bauteilen
- *Heavy-duty components designed and optimized with modern Finite Elements Calculation Programs*
- *Large frame cross-sections, optimized for durability and low material tension*
- *High-lasting materials in highly stressed components*



- Verwindungssteife Kastenbauweise
- Heavy Duty Achsen-Technik – hochwertige Komponenten
- Geschützte Antriebsstränge
- Hohe Zugkraft, zügige Fahrbewegungen
- *Buckling resistant box construction*
- *Heavy duty axles technology – high-quality components*
- *Protected drive trains*
- *High traction, speedy operation movements*



- Stabile und bestmöglich geschützte Abstützungen
- Bester Stand in jedem Einsatz, auch bei hohen Dynamiken
- Zentrales Schmiersystem für einfachen und schnellen Service
- *Stable and best-protected outriggers*
- *Best stand in any operation even at high dynamics*
- *Central lubrication system for easy and quick service*



Oberwagen: Robust und serviceorientiert

Upper carriage: Robust and service-oriented

Für den schweren Materialumschlag gebaut

Built for heavy duty material handling

- Robuste Seitendeckel am Oberwagen aus Stahlblech
- Hydraulisch hochfahrbare Kabine mit ausgezeichneter Übersicht auf das Arbeitsfeld
- Stabile Kabinenerhöhung für ruhiges Arbeiten
- Stabile und großzügig dimensionierte Rahmenquerschnitte vom Ausleger bis zum Ballast
- *Robust side doors made of steel sheet on the upper carriage*
- *Hydraulic elevating cab with excellent site overview*
- *Strong cab elevation for smooth operation*
- *Stable and spacious frame cross-sections from boom to ballast*

Oberwagen: Alles auf einen Blick

Upper carriage: Everything at a glance

Zentrale Messpunkte

Central measurement points

Dynamische und starke Drehantriebe

Dynamic and powerful swing drives

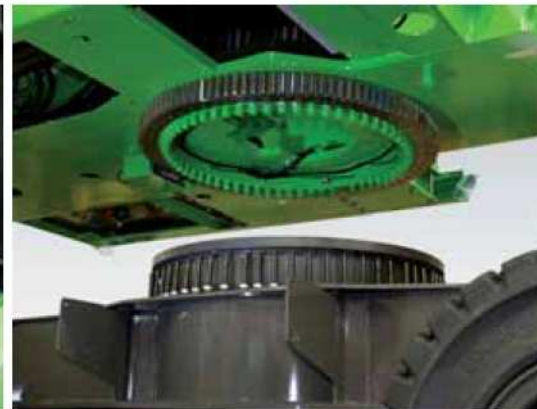

- Einfache und sichere Zugänglichkeit zu allen Wartungspunkten, Luftfilter und Batterien
- Komfortable und sichere Betankung
- Vertikal öffnende Seitenklappen bieten Witterungsschutz im Serviceeinsatz
- Bestmögliche Schalldämmung
- *Easy and safe accessibility to all service points, air filters and batteries*
- *Easy and safe refueling*
- *Vertical opening of side doors offer weather protection at operation*
- *The best possible sound insulation*

- Zentrale Hydraulik-Messpunkte zur einfachen und schnellen Überprüfung der gesamten Hydraulik-Anlage
- *Central hydraulic measuring points for easy and quick inspection of the entire hydraulic system*

- Extra starke Drehkränze
- Hohe Antriebsleistung für effektive und schnelle Schwenkbewegungen
- Energiesparendes Schwenken im geschlossenen hydraulischen Kreis
- *Extra strong slewing rings*
- *High drive power for fast, effective slewing movements*
- *Energy-saving slewing due to the closed hydraulic circuit*

Kabinen, Komfort und Sicherheit

Cabins, comfort and safety



Kabine maXcab Industrie

Cabin maXcab Industry

- Mit durchgehender und nach innen geneigter Panzerglas-Frontscheibe
- *With top to bottom inwardly inclined bullet-proof front windscreen*

Komfortkabine maXcab

Comfort cabin maXcab

- Luftgefederter und individuell einstellbarer Komfortsitz
- Gleichmäßiges Raumklima dank starker Klimautomatik mit 9 Lüftungsdüsen
- Optimale Rundumsicht
- Komfortable Joystick-Steuerung, höchste Feinfühligkeit auch bei überlagerten Bewegungen
- Schiebetür für komfortablen Ein- und Ausstieg
- Stabiler Trittrost mit Geländer vor der Kabine
- Ausstellbares Frontfenster

- *Air-cushioned and individually adjustable comfort seat*
- *Consistent climate due to a strong air-condition with 9 air outlet nozzles*
- *Excellent panoramic view*
- *Convenient joystick control, high sensitivity even at superposed movements*
- *Joystick-steering for best visibility (mobile machines)*
- *Sliding door for convenient cabin entry and exit*
- *Safety-plus: a stable step grid with railing in front of the cabin*
- *Hinged front-window*

Kabine PortCab

Cabin PortCab



- Großraumkabine für Hafen- und Industrieinsätze
- *Very spacious cabin for port and industrial applications*

Sicher oben bleiben

Stay safe on top



- Sicherer Stand auf den Arbeitsbereichen durch rutschfeste Oberflächen
- *Safer stand on non-slip surfaces at the work areas*

Sicherheit geht über alles

Safety above all



- Sicherheit auf dem Oberwagen durch stabile umlaufende Galerien
- Sicherer Aufstieg auf den Oberwagen durch viele stabile Haltepunkte und Geländer
- *Safety on the upper carriage with stable circular galleries*
- *Safe access to the upper carriage with many stable holding points and railings*

Ausrüstung, Kinematik und Traglast

Equipment, kinematics and load capacity

Hoch belastbare Ausrüstung

Heavy-duty equipment

- Große Arbeitsbereiche, auf den Materialumschlag abgestimmte Kinematik
 - Maximale Traglasten bei großen Reichweiten und Reichhöhen
 - Kasten- oder Banana-Ausleger
 - Stiel optional mit ULM für den Einsatz mit Sortiergreifer
 - Große Lagerstellen für Dauerfestigkeit
 - Hochwertige Hydraulikzylinder
- *Large working ranges, kinematics designed for material handling applications*
 - *Maximum handling capacities at enormous reach and height*
 - *Box- or banana-boom*
 - *Stick with ULM optional for use with a sorting grab*
 - *Large bearings for fatigue resistance*
 - *High-class hydraulic cylinders*



Schnellwechselsysteme

Quick-coupling systems



- Schnellwechselsystem Multi-Tool, halb- und vollautomatisch
 - Wechsel des Werkzeugs von der Kabine aus bei Vollautomatik
- *Quick-coupling system Multi-Tool, semi- and fully automatic*
 - *Change the working tool from the cab with the fully automatic system*

Vario Tool

Vario Tool



- Für schnellsten Werkzeugwechsel beim 830 von der Kabine aus
 - Wechselstiel mit vollautomatischen hydraulischen Kupplungen
- *For fastest tool changing for the 830 from the cab*
 - *Exchangeable stick with fully automatic hydraulic couplings*

Schutz von Leitungen und Schläuchen

Protection of cables and hoses



Beispiel/Example: 818 M

- Auf die Applikation abgestimmte Schlauchanordnung
 - Zylinderanordnung für bestmöglichen Schutz der Komponenten
- *Matching to the application: hose assembly*
 - *Cylinder alignment for maximum protection of the components*

Modularer Aufbau – vielseitige Lösungen

modular design – manifold solutions

Anbaugeräte

attachment tools

-  **Mehrschalengreifer**
orange-peel grab
-  **Zweischalengreifer**
clamshell grab
-  **Magnetplatte**
magnet plates
-  **Schrottschere**
Mobile shear types
-  **Vakuum-Traverse**
vacuum lifting device





Varianten Ausrüstungen

variants equipment



Kabinen



cabins

-  **maXcab**
D270 mit maXcab
D270 with maXcab
-  **maXcab**
D300/260 mit maXcab
D300/260 with maXcab
-  **maXcab**
Skylift Typ 600 mit maXcab
skylift Typ 600 with maXcab
-  **maXcab**
Skylift Typ 600 mit PortCab
skylift Typ 600 with PortCab

Oberwagen

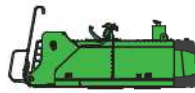
upper carriage



-  **Diesel-hydraulischer Antrieb**
diesel-hydraulic drive
-  **Elektro-hydraulischer Antrieb**
electro-hydraulic drive

Optionen

options

-  **Motorleitungstrommel**
motorized cable reel
-  **Transformator**
transformer

Varianten Unterwagen

variants undercarriage

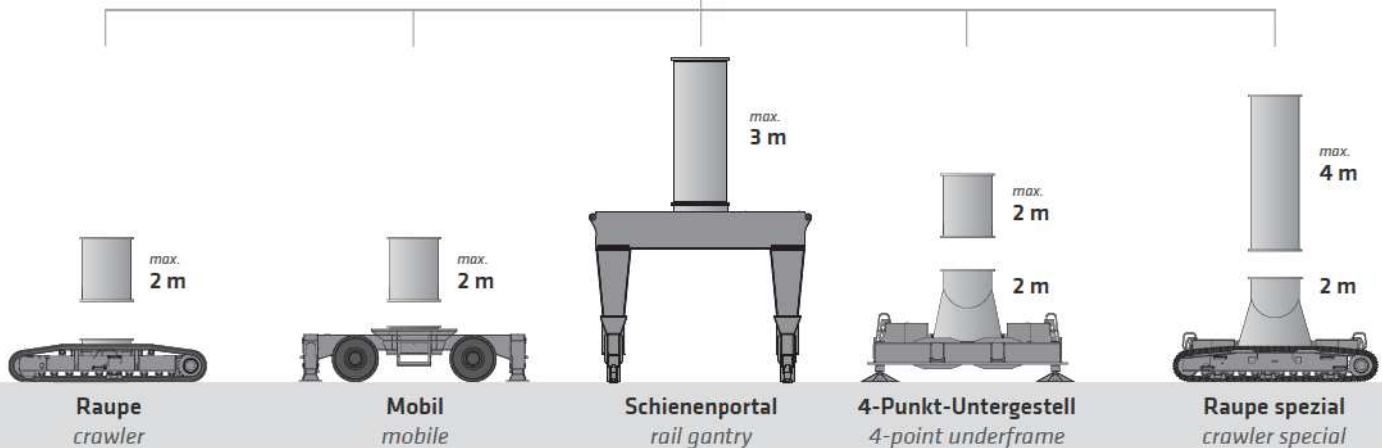

Maschinen für kunden- spezifische Anforderungen *Machines for customer- specific requirements*

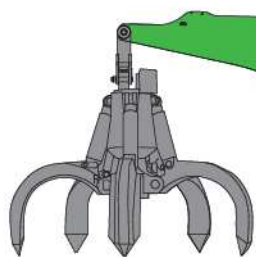

Ihre Anforderungen an den Umschlag von Materialien sind individuell. Genauso individuell sollte Ihre SENNEBOGEN-Maschine sein, die Sie aus einem Baukastensystem für Ihren Einsatz konfigurieren.

Die modulare Konstruktion ermöglicht, kundenspezifische Maschinen in Serie zu bauen. Die große Vielfalt an Lösungen, die wir auf diese Weise realisieren, ist weltweit einzigartig. Wie sieht Ihre Maschine aus?

Your material handling requirements are individual. And your SENNEBOGEN machine should be just as individual, configurable for your specific use from a modular system.

The modular construction enables us to build customer-specific machines in series production. The wide range of solutions realised in this way is unique all over the world. What will your machine be like?



Beispiel 860
Example 860



818 Material-Umschlagmaschine

Material Handling Machine

 97 kW / 132 HP Motorleistung <i>engine power</i>	 K9 / K11 / K9 ULM Ausrüstung <i>equipment</i>	 2,30 m Heckradius <i>tail radius</i>
 75 kW, 400 V, 50 Hz Elektro (alternativ) <i>electro (alternative)</i>	 2,7 t Traglast bei 11 m Reichweite ¹ <i>lift capacity at 11 m reach ¹</i>	 2,50 m Oberwagenbreite <i>upper carriage width</i>
 19,9 t – 21,5 t Einsatzgewicht <i>service weight</i>	 450 l empfohlener Mehrschalengreifer <i>recommended orange-peel grab</i>	 0 – 8 min⁻¹ / 0 – 8 rpm Drehgeschwindigkeit <i>swing speed</i>
 330 l Kraftstofftankinhalt <i>fuel tank</i>	 260 l Hydrauliktank <i>hydraulic tank</i>	 5 m Sichthöhe ² <i>eye level ²</i>

¹ Bei Mobilunterwagen in 3 m Höhe *1 With mobile undercarriage in 3 m height*

² Bei Mobilunterwagen mit Kabine Multicab D220 *2 With mobile undercarriage and cabin Multicab D220*

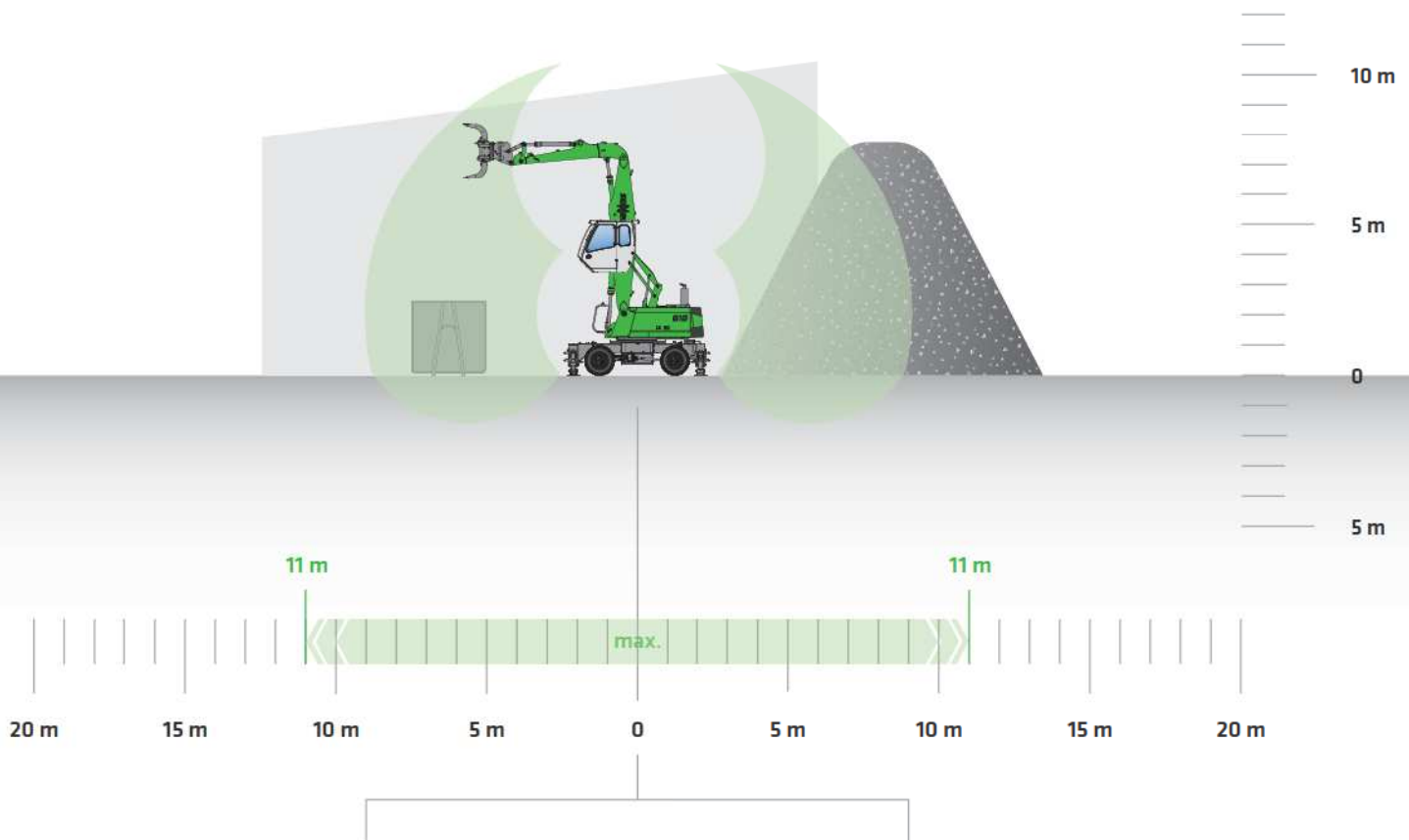

Mobil
mobile



Raupe
crawler



818 M – Ausrüstung K9 – 450 Liter Mehrschalengreifer – Deutschland
818 M – equipment K9 – 450 litre orange-peel grab – Germany



818 M – Ausrüstung K9 ULM – 400 Liter Sortiergreifer – Spanien
818 M – equipment K9 ULM – 400 litre sorting grab – Spain

821 Material-Umschlagmaschine

Material Handling Machine

 97 kW / 132 HP Motorleistung <i>engine power</i>	 K9 / K11 / K12 / B11 ULM Ausrüstung <i>equipment</i>	 2,30 m Heckradius <i>tail radius</i>
 75 kW, 400 V, 50 Hz Elektro (alternativ) <i>electro (alternative)</i>	 2,2 t Traglast bei 12 m Reichweite ¹ <i>lift capacity at 12 m reach¹</i>	 2,50 m Oberwagenbreite <i>upper carriage width</i>
 22 t Einsatzgewicht <i>service weight</i>	 600 l empfohlener Mehrschalengreifer <i>recommended orange-peel grab</i>	 0 – 8 min⁻¹ / 0 – 8 rpm Drehgeschwindigkeit <i>swing speed</i>
 300 l Kraftstofftankinhalt <i>fuel tank</i>	 250 l Hydrauliktank <i>hydraulic tank</i>	 5,70 m Sichthöhe ² <i>eye level²</i>

¹ Bei Mobilunterwagen in 3 m Höhe *1 With mobile undercarriage in 3 m height*

² Bei Mobilunterwagen mit Kabinenerhöhung D270 ohne Pylon *2 With mobile undercarriage and cabin elevation D270 without pylon*

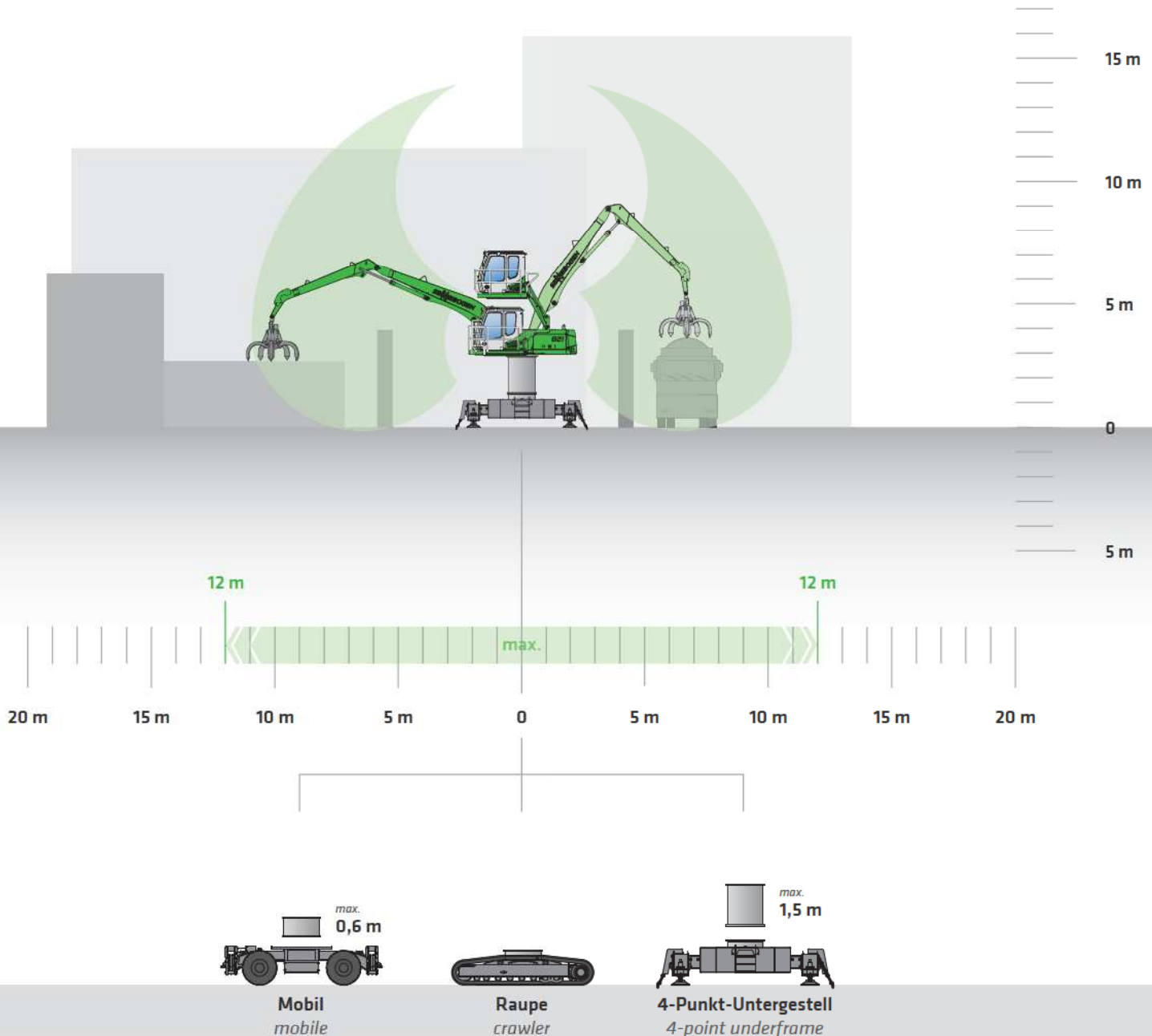



821 M – Ausrüstung K12 – 600 Liter Mehrschalengreifer – Bulgarien
821 M – equipment K12 – 600 litre orange-peel grab – Bulgaria



821 A spezial – stationär Elektro – Ausrüstung K12 – 600 Liter Mehrschalengreifer – Italien
821 A special – stationary electro – equipment K12 – 600 litre orange-peel grab – Italy



821 R – Ausrüstung K11 – 400 Liter Mehrschalengreifer – USA
821 R – equipment K11 – 400 litre orange-peel grab – USA



821 M – Ausrüstung K12 – 600 Liter Mehrschalengreifer – Rumänien
821 M – equipment K12 – 600 litre orange-peel grab – Romania



821 M – Ausrüstung K11 – 600 Liter Mehrschalengreifer mit Magnetplatte – Neuseeland
821 M – equipment K11 – 600 litre orange-peel grab with magnet plate – New Zealand



821 M – Ausrüstung K11 – Magnetplatte – Frankreich
821 M – equipment K11 – magnet plate – France

825 Material-Umschlagmaschine

Material Handling Machine

 129 kW / 175 HP Motorleistung <i>engine power</i>	 K12 / K13 / K12 ULM Ausrüstung <i>equipment</i>	 2,80 m Heckradius <i>tail radius</i>
 110 kW, 400 V, 50 Hz Elektro (alternativ) <i>electro (alternative)</i>	 3,4 t Traglast bei 13 m Reichweite ¹ <i>lift capacity at 13 m reach¹</i>	 2,80 m Oberwagenbreite <i>upper carriage width</i>
 27,9 – 33 t Einsatzgewicht <i>service weight</i>	 600 l empfohlener Mehrschalengreifer <i>recommended orange-peel grab</i>	 0 – 8 min⁻¹ / 0 – 8 rpm Drehgeschwindigkeit <i>swing speed</i>
 480 l Kraftstofftankinhalt <i>fuel tank</i>	 310 l Hydrauliktank <i>hydraulic tank</i>	 5,60 m Sichthöhe ² <i>eye level²</i>

1 Bei Mobilunterwagen in 3 m Höhe *1 With mobile undercarriage in 3 m height*

2 Bei Mobilunterwagen mit Kabinenerhöhung D270 ohne Pylon *2 With mobile undercarriage and cabin elevation D270 without pylon*

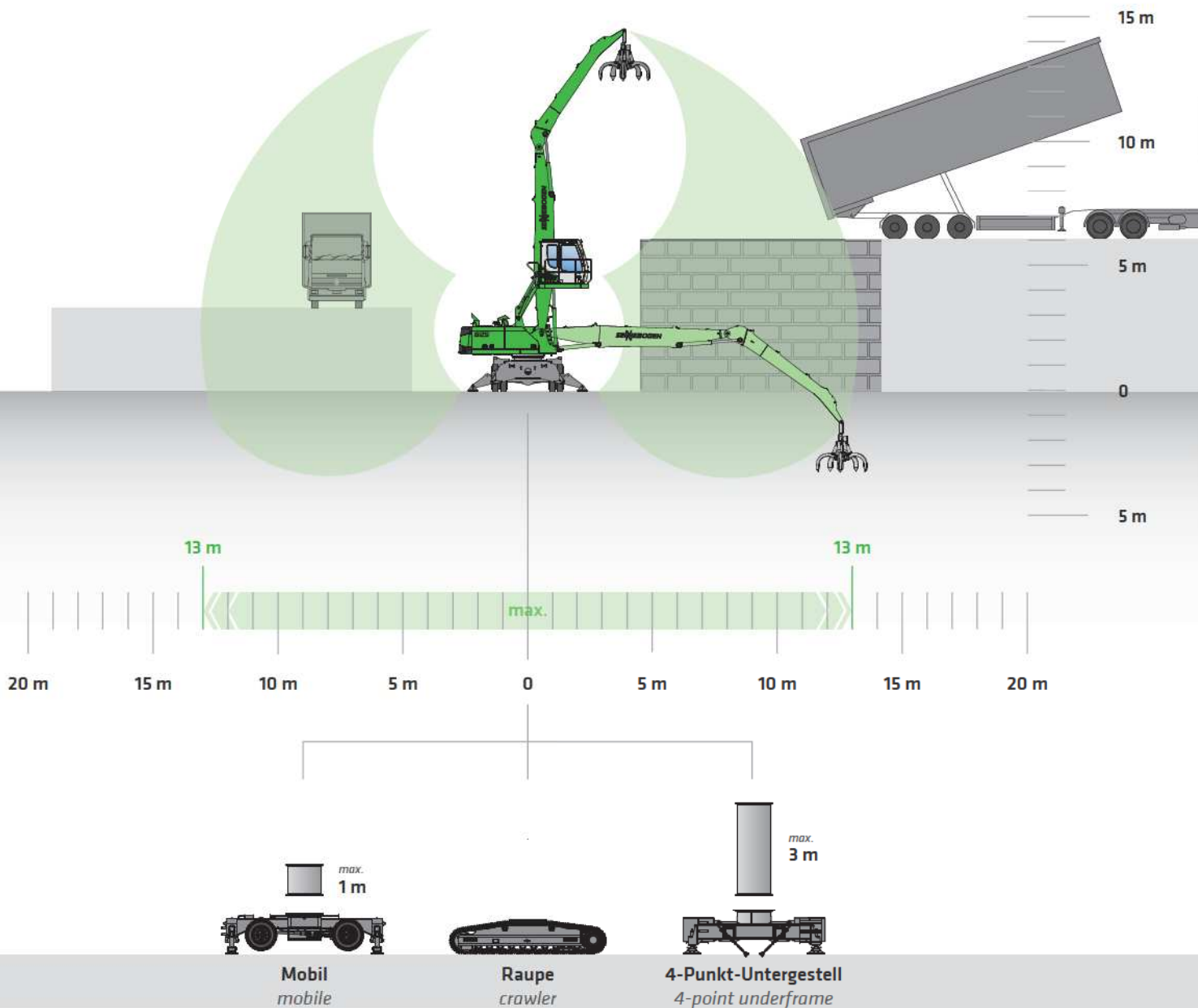



825 M – Ausrüstung K13 – 600 Liter Mehrschalengreifer – USA
825 M – equipment K13 – 600 litre orange-peel grab – USA



825 M – Ausrüstung K12 – 600 Liter Mehrschalengreifer – Deutschland
825 M – equipment K12 – 600 litre orange-peel grab – Germany



825 M - Sonderausrüstung - Deutschland
825 M - special equipment - Germany



825 A spezial - Elektro auf Schienenunterwagen - 2,5 m Pylon - Ausrüstung K12 - 600 Liter Mehrschalengreifer - Schweiz
825 A special - electro on rail undercarriage - 2.5 m pylon - equipment K12 - 600 litre orange-peel grab - Switzerland



825 M - Ausrüstung K12 - 600 Liter Mehrschalengreifer - Neuseeland
825 M - equipment K12 - 600 litre orange-peel grab - New Zealand



825 M - Ausrüstung K13 - Magnetplatte - Deutschland
825 M - equipment K13 - magnet plate - Germany

830 Material-Umschlagmaschine

Material Handling Machine

 151 kW / 205 HP Motorleistung <i>engine power</i>	 K15 / K17 / B16 / K14 ULM Ausrüstung <i>equipment</i>	 3,15 m Heckradius <i>tail radius</i>
 132 kW, 400 V, 50 Hz Elektro (alternativ) <i>electro (alternative)</i>	 3,3 t Traglast bei 17 m Reichweite ¹ <i>lift capacity at 17 m reach¹</i>	 2,80 m Oberwagenbreite <i>upper carriage width</i>
 36 t - 42 t Einsatzgewicht <i>service weight</i>	 600 l - 800 l empfohlener Mehrschalengreifer <i>recommended orange-peel grab</i>	 0 - 8 min⁻¹ / 0 - 8 rpm Drehgeschwindigkeit <i>swing speed</i>
 480 l Kraftstofftankinhalt <i>fuel tank</i>	 310 l Hydrauliktank <i>hydraulic tank</i>	 5,60 m Sichthöhe ² <i>eye level²</i>

¹ Bei Mobilunterwagen in 3 m Höhe *1 With mobile undercarriage in 3 m height*

² Bei Mobilunterwagen mit Kabinenerhöhung D270 ohne Pylon *2 With mobile undercarriage and cabin elevation D270 without pylon*

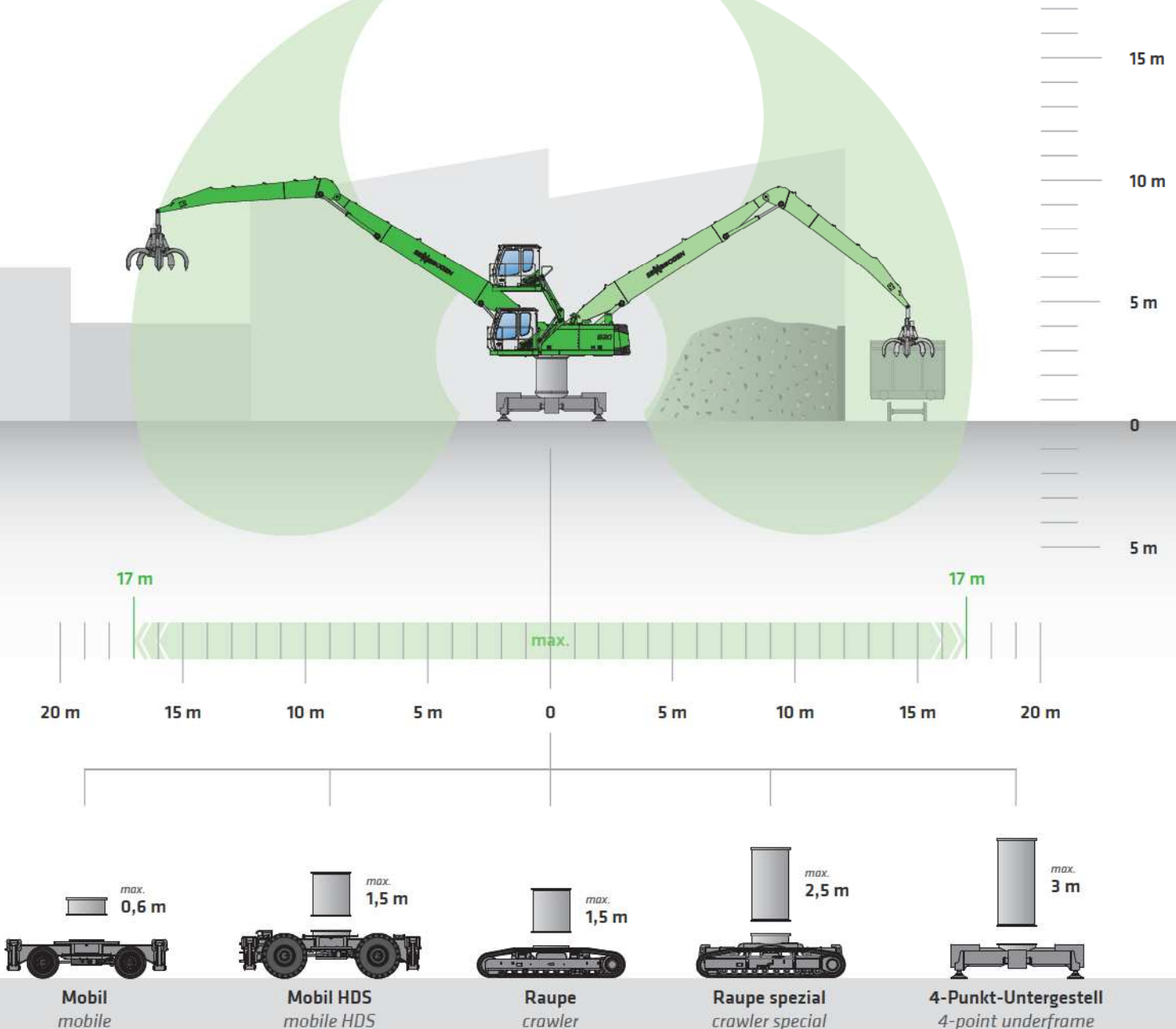



830 R – Sonderausrüstung K12 ULM – Schrottschere – Italien
830 R – special equipment K12 ULM – scrap shear – Italy



830 M-HDS: Heavy Duty Ausführung mit großer Einfach-Bereifung 4 x 16.00-25
830 M-HDS: Heavy Duty design with large single tires 4 x 16,00-25



830 M – Ausrüstung K15 – 800 Liter Mehrschalengreifer – Deutschland
830 M – equipment K15 – 800 litre orange-peel grab – Germany



830 R – Ausrüstung K15 – 600 Liter Mehrschalengreifer – Frankreich
830 R – equipment K15 – 600 litre orange-peel grab – France



830 M – Ausrüstung K15 – 800 Liter Mehrschalengreifer – Schweden
830 M – equipment K15 – 800 litre orange-peel grab – Sweden



830 M – Ausrüstung K15 – 800 Liter Mehrschalengreifer – Australien
830 M – equipment K15 – 800 litre orange-peel grab – Australia



830 M – Vario Tool – Ausrüstung K13 – Schrottschere – Deutschland
830 M – vario tool – equipment K13 – scrap shear – Germany



830 M spezial – 1 m Pylon – Ausrüstung K15 – 600 Liter Mehrschalengreifer – Ukraine
830 M special – 1 m pylon – equipment K15 – 600 litre orange-peel grab – Ukraine

835 Material-Umschlagmaschine

Material Handling Machine

194 kW / 261 HP
Motorleistung
engine power

160 kW, 400 V, 50 Hz
Elektro (alternativ)
electro (alternative)

44 t - 69 t
Einsatzgewicht
service weight

600 l
Kraftstofftankinhalt
fuel tank

K16 / K18 / B18 / B19 / K20
Ausrüstung
equipment

4 t
Traglast bei 18 m Reichweite¹
lift capacity at 18 m reach¹

600 l - 800 l
empfohlener Mehrschalengreifer
recommended orange-peel grab

500 l
Hydrauliktank
hydraulic tank

3,30 m
Heckradius
tail radius

3 m
Oberwagenbreite
upper carriage width

0 - 8 min⁻¹ / 0 - 8 rpm
Drehgeschwindigkeit
swing speed

5,60 m
Sichthöhe²
eye level²

¹ Bei Mobilunterwagen in 3 m Höhe ¹ With mobile undercarriage in 3 m height

² Bei Mobilunterwagen mit Kabinenerhöhung D270 ohne Pylon ² With mobile undercarriage and cabin elevation D270 without pylon

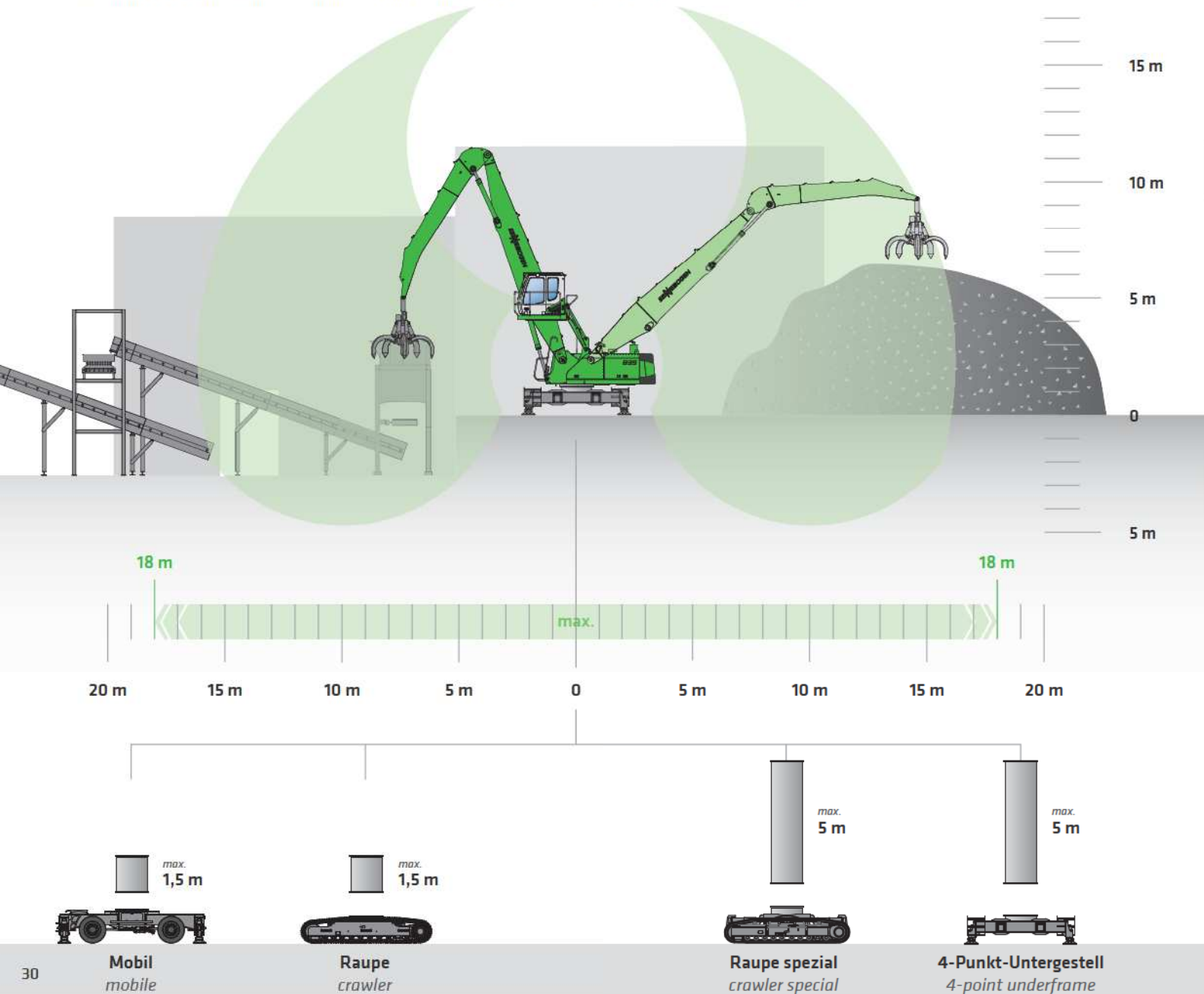



835 M – Ausrüstung K18 – 400 Liter Mehrschalengreifer – Deutschland
835 M – equipment K18 – 400 litre orange-peel grab – Germany



835 A spezial – 4 m Pylon – Sonderausrüstung K20 – 600 Liter Mehrschalengreifer – USA
835 A special – 4 m pylon – special equipment K20 – 600 litre orange-peel grab – USA



835 R spezial - 5 m Pylon - Ausrüstung K20 - 800 Liter Mehrschalengreifer - Frankreich
835 R special - 5 m pylon - equipment K20 - 800 litre orange-peel grab - France



835 R spezial - 5 m Pylon - Ausrüstung B19 - 1.200 Liter Mehrschalengreifer - Taiwan
835 R special - 5 m pylon - equipment B19 - 1,200 litre orange-peel grab - Taiwan



835 R - Ausrüstung K15 - Magnetplatte - Kanada
835 R - equipment K15 - magnet plate - Canada



835 R spezial – 5 m Pylon – Ausrüstung K21 – 600 Liter Mehrschalengreifer – Deutschland
835 R special – 5 m pylon – equipment K21 – 600 litre orange-peel grab – Germany



835 M spezial – 1,5 m Pylon – Ausrüstung K18 – 1.000 Liter Mehrschalengreifer – Belgien
835 M special – 1.5 m pylon – equipment K18 – 1,000 litre orange-peel grab – Belgium

840 Material-Umschlagmaschine

Material Handling Machine

 194 kW / 261 HP Motorleistung <i>engine power</i>	 K17 / K18 / B18 Ausrüstung <i>equipment</i>	 3,30 m Heckradius <i>tail radius</i>
 160 kW, 400 V, 50 Hz Elektro (alternativ) <i>electro (alternative)</i>	 4,9 t Traglast bei 18 m Reichweite ¹ <i>lift capacity at 18 m reach¹</i>	 3 m Oberwagenbreite <i>upper carriage width</i>
 52 t - 58 t Einsatzgewicht <i>service weight</i>	 800 l - 1.000 l empfohlener Mehrschalengreifer <i>recommended orange-peel grab</i>	 0 - 8 min⁻¹ / 0 - 8 rpm Drehgeschwindigkeit <i>swing speed</i>
 600 l Kraftstofftankinhalt <i>fuel tank</i>	 500 l Hydrauliktank <i>hydraulic tank</i>	 6,0 m Sichthöhe ² <i>eye level²</i>

¹ Bei Mobilunterwagen in 3 m Höhe *1 With mobile undercarriage in 3 m height*

² Bei Mobilunterwagen mit Kabinenerhöhung D270 ohne Pylon *2 With mobile undercarriage and cabin elevation D270 without pylon*

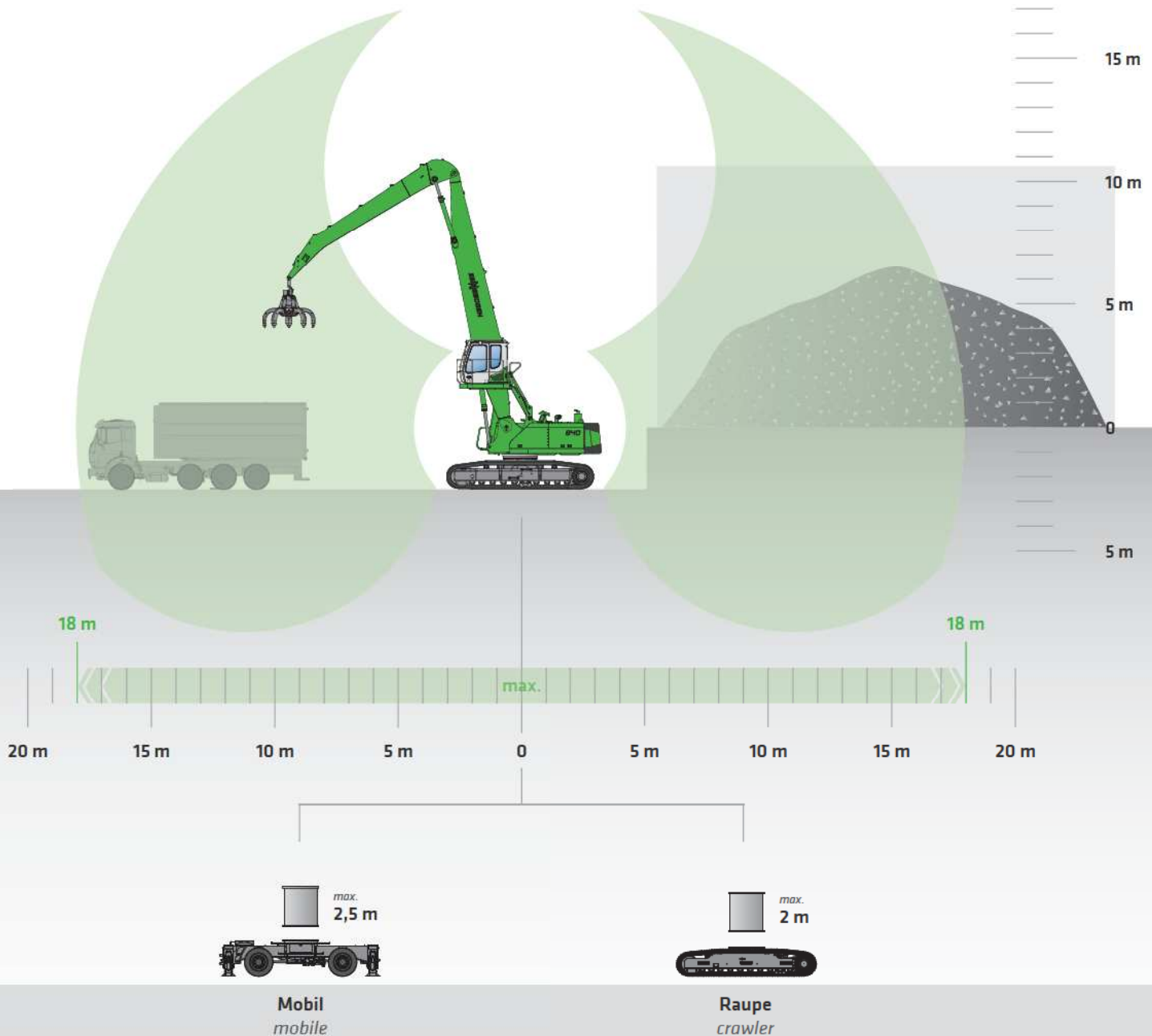



840 M spezial – 1 m Pylon – Ausrüstung K17 – 800 Liter Mehrschalengreifer – Spanien
840 M special – 1 m pylon – equipment K17 – 800 litre orange-peel grab – Spain



840 M – Ausrüstung K18 – 800 Liter Mehrschalengreifer – Deutschland
840 M – equipment K18 – 800 litre orange-peel grab – Germany



840 M spezial – 2,5 m Pylon – Sonderausrüstung B19 – Polen
840 M special – 2.5 m pylon – special equipment B19 – Poland



840 M – Ausrüstung K17 – 1.200 Liter Mehrschalengreifer inkl. Magnet mit Greiferaufnahmedorn – USA
840 M – equipment K17 – 1,200 litre orange-peel grab incl. magnet with grab attachment device – USA



840 R – Ausrüstung K18 – 1.000 Liter Mehrschalengreifer – USA
840 R – equipment K18 – 1,000 litre orange-peel grab – USA

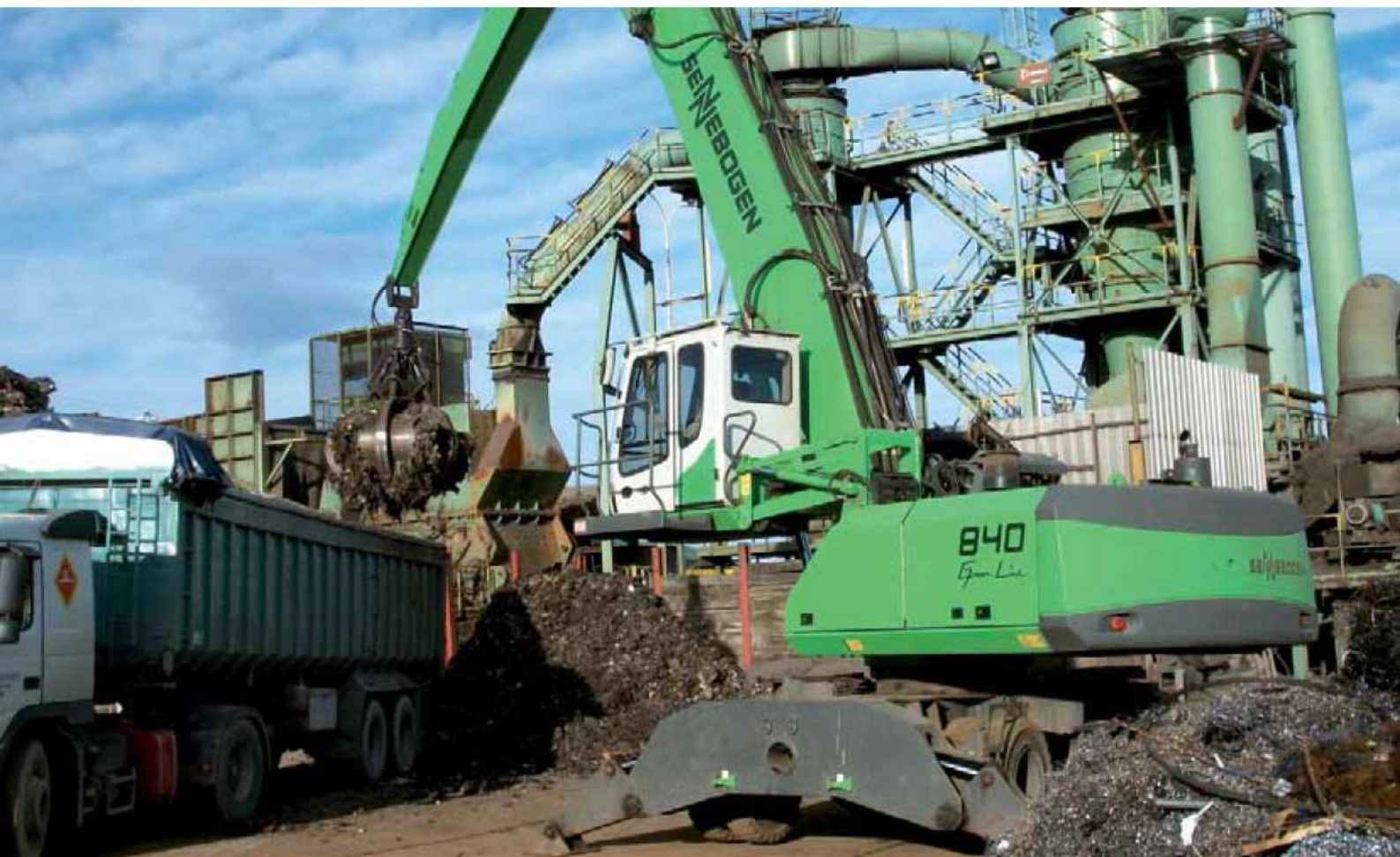

840 M – Ausrüstung K16 – 800 Liter Mehrschalengreifer – Spanien
840 M – equipment K16 – 800 litre orange-peel grab – Spain

850 Material-Umschlagmaschine

Material Handling Machine

268 kW / 364 HP
Motorleistung
engine power

250 kW, 400 V, 50 Hz
Elektro (alternativ)
electro (alternative)

61 t – 88 t
Einsatzgewicht
service weight

880 l
Kraftstofftankinhalt
fuel tank

K17 / K19 / K21 / B17 / B19 / B20
Ausrüstung
equipment

5,5 t
Traglast bei 21 m Reichweite¹
lift capacity at 21 m reach¹

1.000 l – 1.200 l
empfohlener Mehrschalengreifer
recommended orange-peel grab

700 l
Hydrauliktank
hydraulic tank

3,60 m
Heckradius
tail radius

3,25 m
Oberwagenbreite
upper carriage width

0 – 6 min⁻¹ / 0 – 6 rpm
Drehgeschwindigkeit
swing speed

6 m
Sichthöhe²
eye level²

1 Bei Mobilunterwagen in 3 m Höhe *1 With mobile undercarriage in 3 m height*

2 Bei Mobilunterwagen mit Kabinenerhöhung D270 ohne Pylon *2 With mobile undercarriage and cabin elevation D270 without pylon*

2 With mobile undercarriage and cabin elevation D270 without pylon

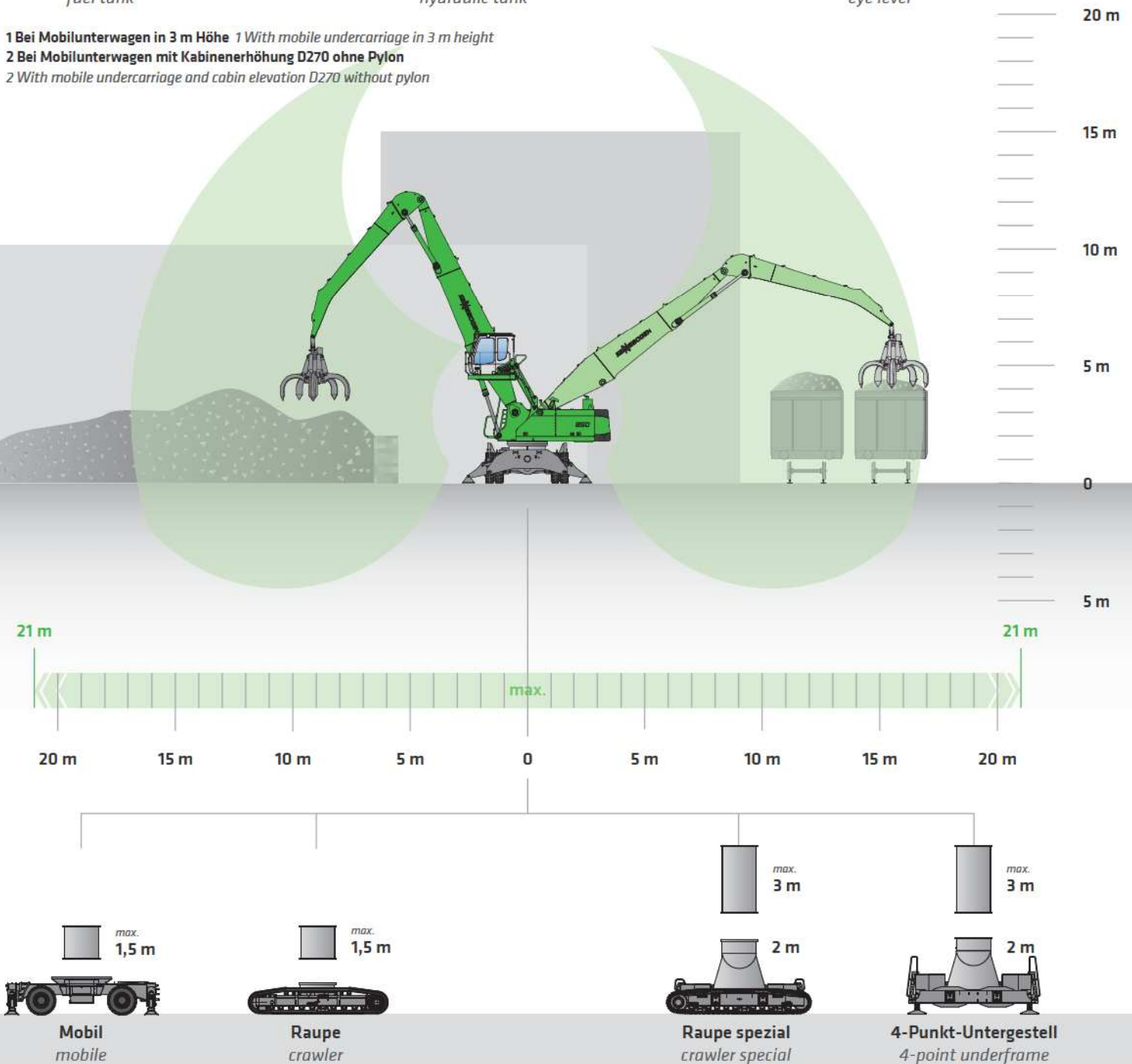



850 A spezial – Schienenunterwagen – Ausrüstung K17 – 1.200 Liter Mehrschalengreifer – USA
850 A special – rail undercarriage – equipment K17 – 1,200 litre orange-peel grab – USA



850 M spezial – 1,5 m Pylon – Ausrüstung K21 – 2.000 Liter Mehrschalengreifer – Russland
850 M special – 1.5 m pylon – equipment K21 – 2,000 litre orange-peel grab – Russia



850 M – Sonderausrüstung – Schrottschere – USA
 850 M – special equipment – scrap shear – USA



850 A spezial – 5 m Pylon – Ausrüstung K21 – 1.200 l Mehrschalengreifer – Kanada
 850 A special – 5 m pylon – equipment K21 – 1,200 l orange-peel grab – Canada



850 R spezial – 5 m Pylon – Ausrüstung K21 – 1.200 l Mehrschalengreifer – Deutschland
 850 R special – 5 m pylon – equipment K21 – 1,200 l orange-peel grab – Germany



850 M spezial - 1,5 m Pylon - Ausrüstung B20 - 1.200 Liter Mehrschalengreifer - Russland
850 M special - 1.5 m pylon - equipment B20 - 1,200 litre orange-peel grab - Russia



850 M - Ausrüstung K17 - Vakuumtraverse - USA
850 M - equipment K17 - vacuum lifting device - USA

860 Material-Umschlagmaschine

Material Handling Machine

286 kW / 364 HP
Motorleistung
engine power

250 kW, 400 V, 50 Hz
Elektro (alternativ)
electro (alternative)

71 t - 97 t
Einsatzgewicht
service weight

880 l
Kraftstofftankinhalt
fuel tank

K18 / K20 / K21 / B20 / B21
Ausrüstung
equipment

6,5 t
Traglast bei 21 m Reichweite¹
lift capacity at 21 m reach¹

1.000 l - 1.400 l
empfohlener Mehrschalengreifer
recommended orange-peel grab

570 l
Hydrauliktank
hydraulic tank

3,80 m
Heckradius
tail radius

3,25 m
Oberwagenbreite
upper carriage width

0 - 6 min⁻¹ / 0 - 6 rpm
Drehgeschwindigkeit
swing speed

6,0 m
Sichthöhe²
eye level²

1 Bei Mobilunterwagen in 3 m Höhe *1 With mobile undercarriage in 3 m height*

2 Bei Mobilunterwagen mit Kabinenerhöhung D270 ohne Pylon *2 With mobile undercarriage and cabin elevation D270 without pylon*

2 With mobile undercarriage and cabin elevation D270 without pylon

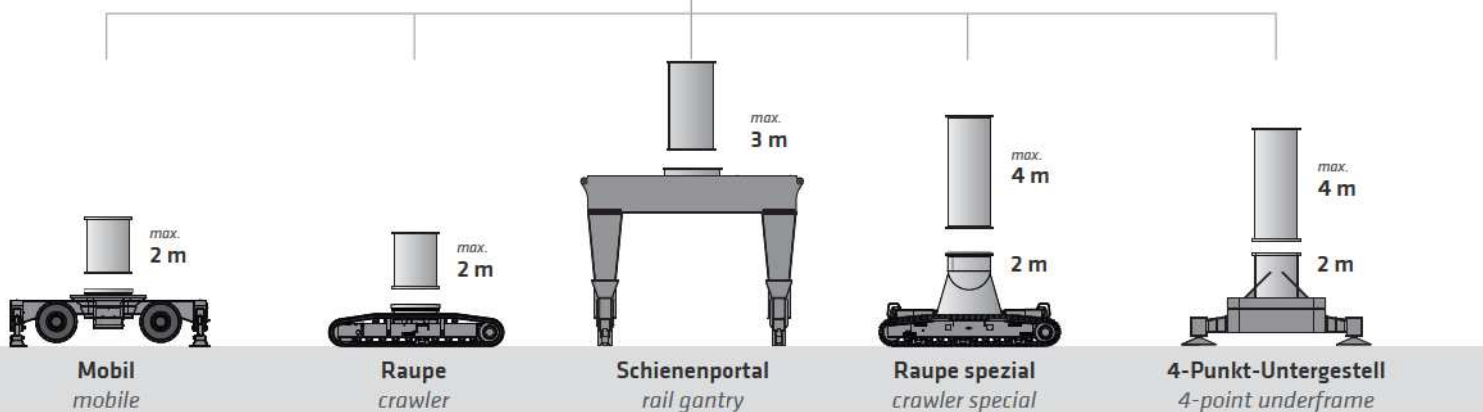
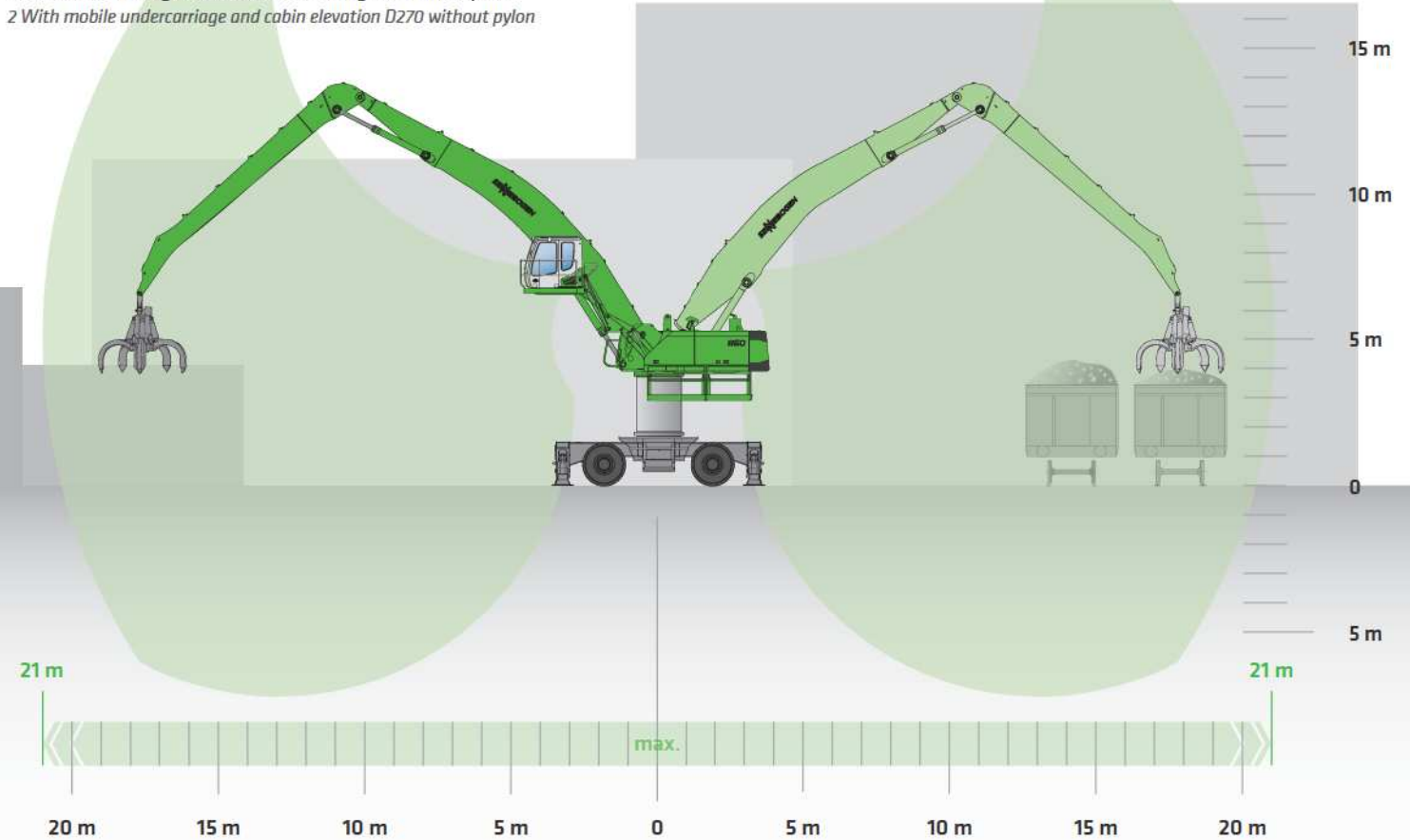



860 M – Ausrüstung K21 – Magnettraverse – Deutschland
860 M – equipment K21 – magnet device – Germany



860 M – Ausrüstung K18 – Magnetplatte – Kanada
860 M – equipment K18 – magnet plate – Canada

870 Material-Umschlagmaschine

Material Handling Machine

-  **300 kW / 408 HP**
Motorleistung
engine power
-  **250 kW, 400 V, 50 Hz**
Elektro (alternativ)
electro (alternative)
-  **66 t - 110 t**
Einsatzgewicht
service weight
-  **900 l**
Kraftstofftankinhalt
fuel tank
-  **K18 / K20 / K22 / K24 / B19 / B21 / B23 / B19 ULM**
Ausrüstung
equipment
-  **7,7 t**
Traglast bei 20 m Reichweite¹
lift capacity at 20 m reach¹
-  **1.200 l - 1.500 l**
empfohlener Mehrschalengreifer
recommended orange-peel grab
-  **850 l**
Hydrauliktank
hydraulic tank
-  **4,20 m**
Heckradius
tail radius
-  **3,30 m**
Oberwagenbreite
upper carriage width
-  **0 - 6,2 min⁻¹ / 0 - 6,2 rpm**
Drehgeschwindigkeit
swing speed
-  **6 m**
Sichthöhe²
eye level²

1 Bei Mobilunterwagen in 3 m Höhe 1 With mobile undercarriage in 3 m height

2 Bei Mobilunterwagen mit Kabinenerhöhung D270 ohne Pylon 2 With mobile undercarriage and cabin elevation D270 without pylon

2 With mobile undercarriage and cabin elevation D270 without pylon

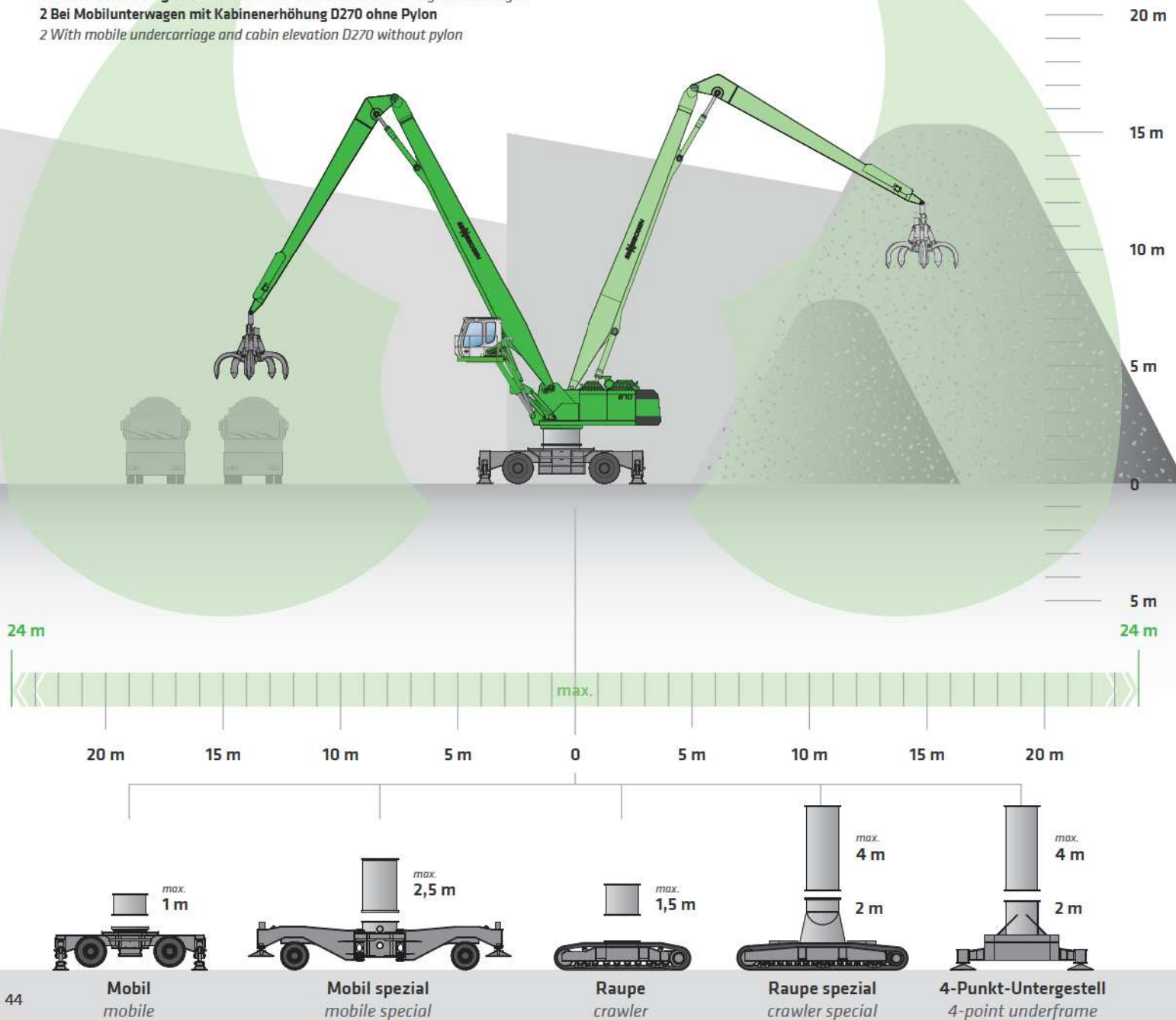



870 M spezial mit Unterwagen MS100 – Ausrüstung K18 – Vakuumtraverse – Deutschland
870 M special with undercarriage MS100 – equipment K18 – vacuum lifting device – Germany



870 R spezial – 5 m Pylon – Ausrüstung B23 – 1.500 Liter Mehrschalengreifer – Taiwan
870 R special – 5 m pylon – equipment B23 – 1,500 litre orange-peel grab – Taiwan



870 M - Ausrüstung K20 - Magnettraverse - Spanien
870 M - equipment K20 - magnet device - Spain



870 R special - 2 m Pylon - Sonderausrüstung K26 - 2.500 l Mehrschalengreifer - Deutschland
870 R special - 2 m pylon - special equipment K26 - 2,500 l orange-peel grab - Germany



870 M - Ausrüstung K18 - 3.000 Liter Mehrschalengreifer - USA
870 M - equipment K18 - 3,000 litre orange-peel grab - USA



870 spezial mit Elastiklager - Ausrüstung K18 - Spezialgreifer - USA
870 special with elastic bearing - equipment K18 - special grab - USA



870 M - Ausrüstung K18 - Magnettraverse - Russland
870 M - equipment K18 - magnet device - Russia



870 M spezial mit Unterwagen MS100 – 2 m Pylon – Ausrüstung B23 – 20 Tonnen Multitool – Italien
870 M special with undercarriage MS100 – 2 m pylon – equipment B23 – 20 tons Multitool – Italy



870 M spezial mit Unterwagen MS100 – 2 m Pylon – Ausrüstung K18 – Vakuumtraverse – Deutschland
870 M special with undercarriage MS100 – 2 m pylon – equipment K18 – vacuum lifting device – Germany



870 R spezial – Elektro – 1 m Pylon – Sonderausrüstung K17 – Kokillentraverse – Schweden
870 R special – electro – 1 m pylon – special equipment K17 – ingot mould lifting device – Sweden



870 M – Ausrüstung K18 – Magnetplatte – Argentinien
870 M – equipment K18 – magnet plate – Argentina

880 classic

Material-Umschlagmaschine Material Handling Machine

 570 kW / 775 HP Motorleistung <i>engine power</i>	 K20 / K25 Ausrüstung <i>equipment</i>	 5,25 m Heckradius <i>tail radius</i>
 520 kW, 400 V, 50 Hz Elektro (alternativ) <i>electro (alternative)</i>	 9,9 t Traglast bei 25 m Reichweite ¹ <i>lift capacity at 25 m reach¹</i>	 3,65 m Oberwagenbreite <i>upper carriage width</i>
 150 t - 180 t Einsatzgewicht <i>service weight</i>	 4.000 l - 6.000 l empfohlener Mehrschalengreifer <i>recommended orange-peel grab</i>	 0 - 5,5 min⁻¹ / 0 - 5,5 rpm Drehgeschwindigkeit <i>swing speed</i>
 1.850 l Kraftstofftankinhalt <i>fuel tank</i>	 1.190 l Hydrauliktank <i>hydraulic tank</i>	 6,50 m Sichthöhe ² <i>eye level²</i>

¹ Bei Mobilunterwagen in 3 m Höhe *1 With mobile undercarriage in 3 m height*

² Bei Raupenunterwagen mit Kabinenerhöhung D300/260 ohne Pylon

2 With crawler undercarriage and cabin elevation D300/260 without pylon

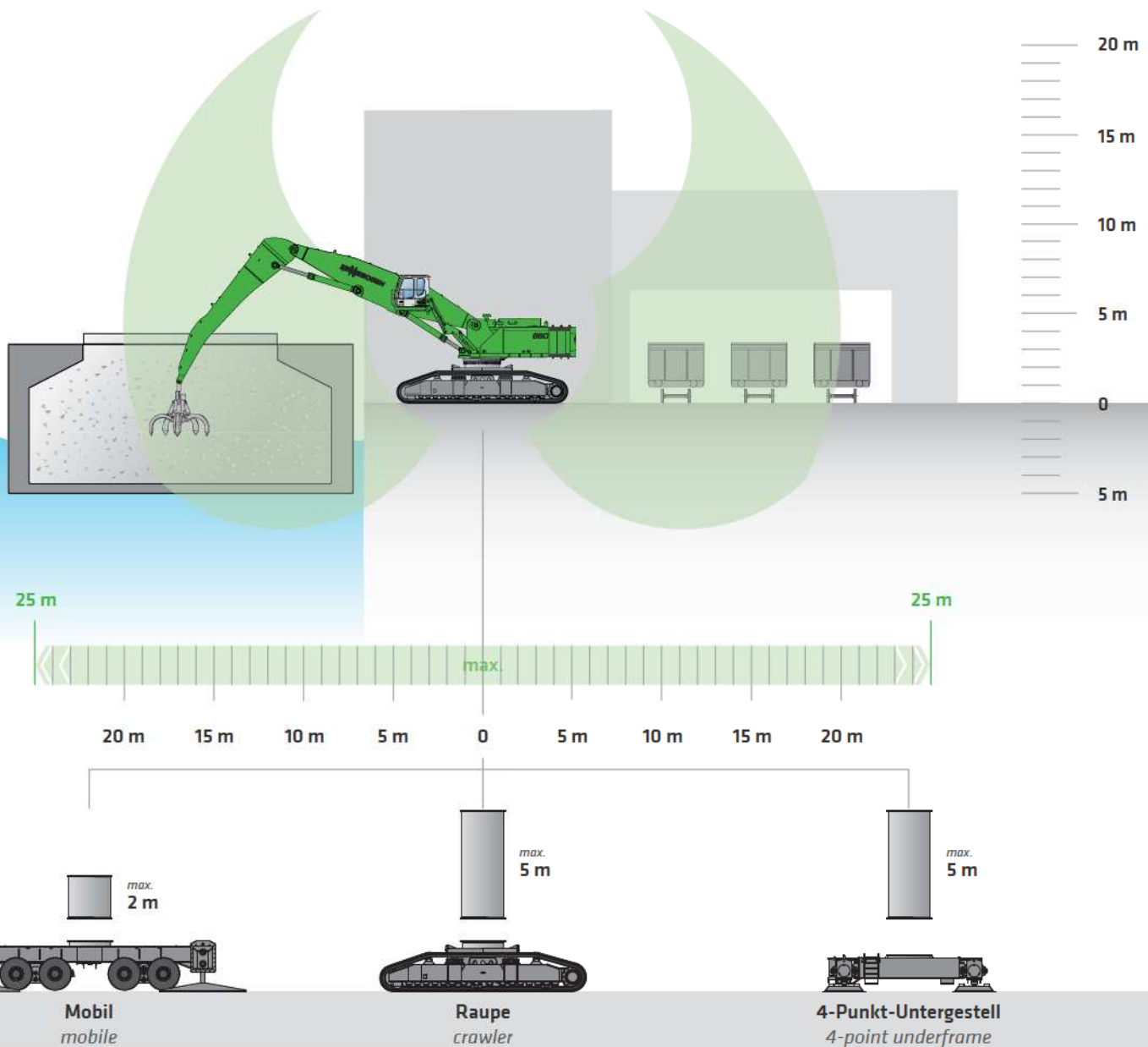



880 R-HD – Elektro – Ausrüstung K20 – 10.500 Liter Zweischalengreifer – USA
880 R-HD – electro – equipment K20 – 10,500 litre clamshell grab – USA



880 R – Elektro – Ausrüstung K20 – 8.000 Liter Mehrschalengreifer – USA
880 R – electro – equipment K20 – 8,000 litre orange-peel grab – USA

880 EQ

Material-Umschlagmaschine Material Handling Machine

- | | | |
|--|--|--|
|  470 kW / 640 HP
Motorleistung
<i>engine power</i> |  K25 / K30 / K33 / K35
Ausrüstung
<i>equipment</i> |  7 m
Heckradius
<i>tail radius</i> |
|  430 kW, 400 V, 50 Hz
Elektro (alternativ)
<i>electro (alternative)</i> |  10,8 t
Traglast bei 35 m Reichweite ¹
<i>lift capacity at 35 m reach¹</i> |  8,95 m
Oberwagenbreite
<i>upper carriage width</i> |
|  215 t - 270 t
Einsatzgewicht
<i>service weight</i> |  6.000 l - 8.000 l
empfohlener Mehrschalengreifer
<i>recommended orange-peel grab</i> |  0 - 2,5 min⁻¹ / 0 - 2,5 rpm
Drehgeschwindigkeit
<i>swing speed</i> |
|  2.000 l
Kraftstofftankinhalt
<i>fuel tank</i> |  1.600 l
Hydrauliktank
<i>hydraulic tank</i> |  12,6 m
Sichthöhe ²
<i>eye level²</i> |

1 Bei Raupenunterwagen in 3 m Höhe

1 With crawler undercarriage in 3 m height

2 Bei Raupenunterwagen mit PortCab und 7 m Pylon

2 With crawler undercarriage and PortCab with 7 m pylon

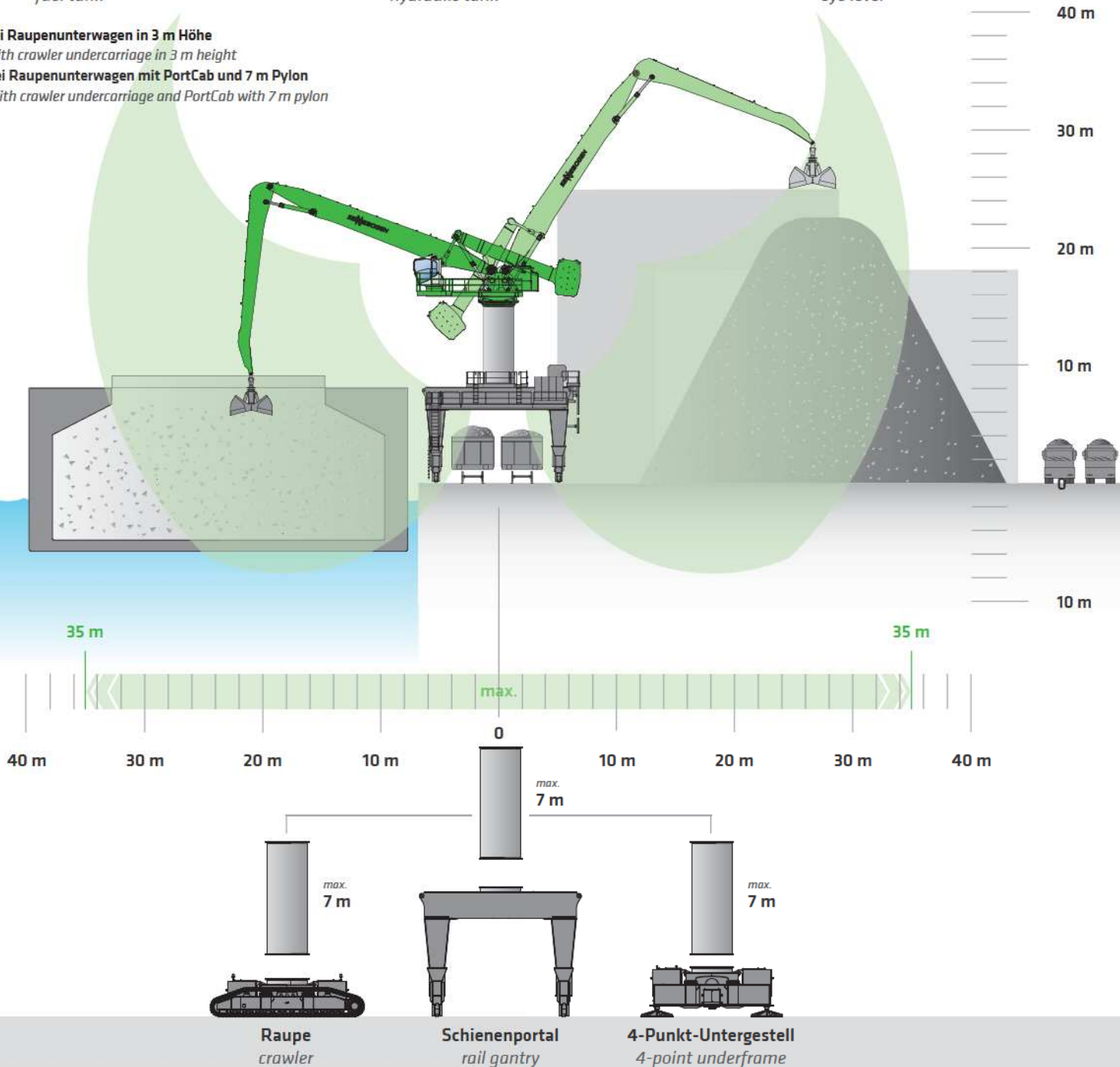



880 EQ R - 7 m Pylon - Ausrüstung K33 - 8.000 Liter Mehrschalengreifer - Türkei
880 EQ R - 7 m pylon - equipment K33 - 8,000 litre orange-peel grab - Turkey



880 EQ - Elektro auf Schienenportal - 6 m Durchfahrthöhe, 10,5 m Spurbreite - Ausrüstung K30 - 4.000 Liter Zweischalengreifer - Russland
880 EQ - electro on rail gantry - 6 m clearance height, 10.5 m track width - equipment K30 - 4,000 litre clamshell grab - Russia



880 EQ R spezial - 7 m Pylon - Ausrüstung K30 - 8.000 Liter Mehrschalengreifer - Türkei
880 EQ R special - 7 m pylon - equipment K30 - 8,000 litre orange-peel grab - Turkey



880 EQ R spezial – 6 m Pylon – Ausrüstung K25 – Multitool mit Traverse – Großbritannien
880 EQ R special – 6 m pylon – equipment K25 – Multitool with lifting device – Great Britain



880 EQ R spezial – 7 m Pylon – Ausrüstung K33 – 10.000 Liter Zweischalengreifer – Indien
880 EQ R special – 7 m pylon – equipment K33 – 10,000 litre clamshell – India



880 EQ R spezial – 7 m Pylon – Ausrüstung K33 – 7.000 Liter Mehrschalengreifer – Indien
880 EQ R special – 7 m pylon – equipment K33 – 7,000 litre orange-peel grab – India

305 Multihandler / 310 Multiloader

Multihandler / Multiloader

 **91 kW / 124 PS / 144 kW / 196 PS**
Motorleistung
engine power

 **0 - 25 km/h / 0 - 22 km/h**
Fahrgeschwindigkeit
travel speed

 **11,5 t / 21 t**
Einsatzgewicht
service weight

 **290 l / 380 l**
Kraftstofftankinhalt
fuel tank

 **7,3 m / 9,3 m**
Hubhöhe
lifting height

 **5 t bei 1,5 m / 10 t bei 2,5 m**
Traglast
lift capacity

 **2.500 l / 5.000 l**
empfohlene Schaufelgröße
recommended bucket size

 **95 l / 160 l**
Hydrauliktank
hydraulic tank

 **2,5 m / 3,0 m**
Transporthöhe
transport height

 **2,5 m / 2,75 m**
Transportbreite
transport width

 **2,9 m / 3,5 m**
Radstand
wheel base

 **4 m / 5 m**
Sichthöhe
eye level

305

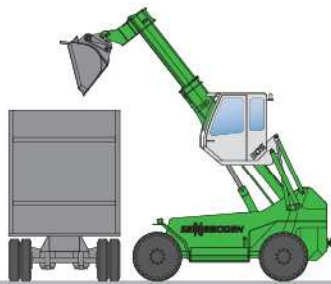

10 m

5 m

0

310

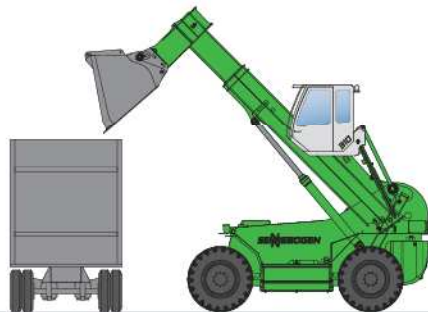

10 m

5 m

0



305 Multihandler – 2.000 Liter Ladeschaufel – USA
305 Multihandler – 2,000 litre bucket – USA



310 Multiloader – 4.000 Liter Ladeschaufel – Österreich
310 Multiloader – 4,000 litre bucket – Austria

HD Seilbagger/Krane

HD Crawler Cranes (Duty Cycle)

HD Seilbagger und Krane überzeugen durch Ihre Robustheit und Vielseitigkeit. Das breite Sortiment an sehr leistungsfähigen Maschinen ermöglicht vielfältige Einsätze rund um den Schrottschlag und das Stahlwerk:

- Dropball-Applikationen mit Magnetgreifer zur Schlackezerkleinerung
- Schrottschlag mit Mehrschalengreifer
- Heavy-Lift-Applikationen für spezielle Hebeaufgaben

Duty cycle crawler cranes impress with their robustness and versatility. The wide range of extremely high-performance machines means that we can offer the perfect solution for a broad variety of tasks in all areas of scrap handling and steelworks:

- Drop ball applications with magnetic grab for slag crushing
- Scrap handling with orange peel grab
- Heavy-lift applications for special lifting tasks



Kabine maXcab Industrie: mit durchgehender Panzerglas-Frontscheibe für Industrie- und Hafeneinsätze
Cabin maXcab industry: with continuous bullet-proof front window for industrial and port applications

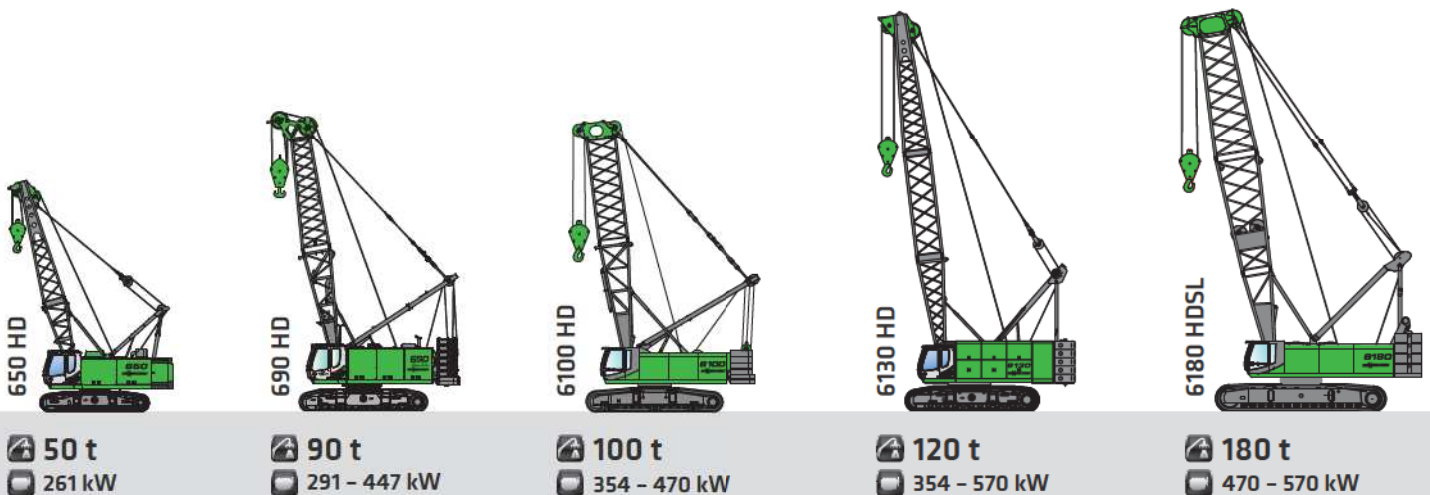



6100 HD - 24,3 m Auslegerlänge - Schlackeverladung mit Magnetplatte - Großbritannien
6100 HD - 24.3 m boom length - slag handling with magnet plate - Great Britain





6100 HD - 24,3 m Auslegerlänge - Schlackezerkleinerung mit Magnetplatte - Kanada
6100 HD - 24.3 m boom length - slag crushing with magnet plate - Canada

Hafenkrane

Harbour Cranes

Die SENNEBOGEN-Hafenkrane ermöglichen eine reibungslose Versorgung des Stahlwerks mit den erforderlichen Rohstoffen sowie das variable Handling von fertigen Stahlprodukten. Mit ihrer flexiblen Konfiguration aus Raupen- und Mobilunterwägen, Maschinenerhöhungen über Pylon und Kabinenerhöhungen ergeben sich für jeden Hafen Lösungen für:

- Den Umschlag von Schrott, Eisenerz, Kohle und anderen Schüttgütern
- Den Umschlag von Stahlcoils, Draht- und Langprodukten sowie Erzeugnissen von NE-Metallen
- Heavy-Lift-Applikationen für spezielle Hebeaufgaben

The SENNEBOGEN harbour cranes are ideal for supplying the steelworks with the required raw materials, as well as enabling variable handling of finished steel products. With their flexible configuration of crawler and mobile undercarriage, raising machines via pylons and elevating cabs, they offer solutions for every port including:

- Handling scrap, iron ore, coal and other bulk material
- Handling steel coils, wire and long products, as well as non-ferrous metal products
- Heavy-lift applications for special lifting tasks

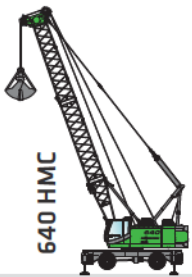

640 HMC

40 t
168 - 205 kW
38 t

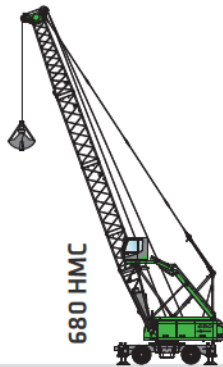

680 HMC

45 t
261 kW
68 t

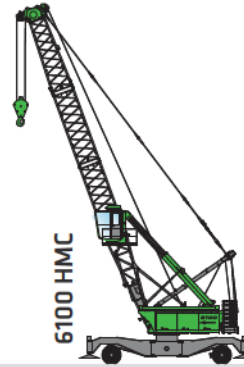

6100 HMC

75 t
354 kW
95 t

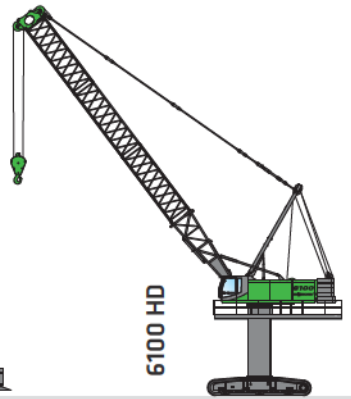

6100 HD

100 t
354 kW
115 t

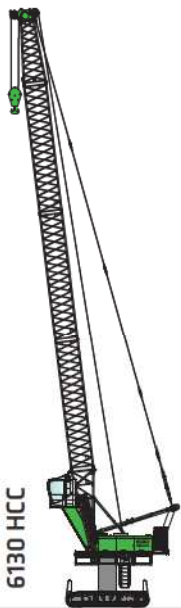

6130 HCC

120 t
400 kW
145 t

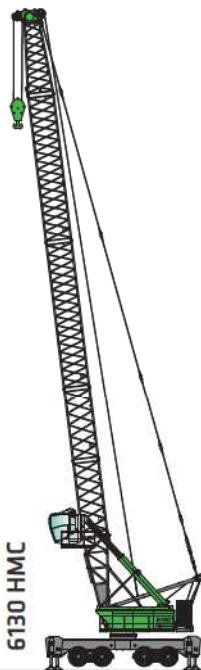

6130 HMC

85 t
400 kW
148 t

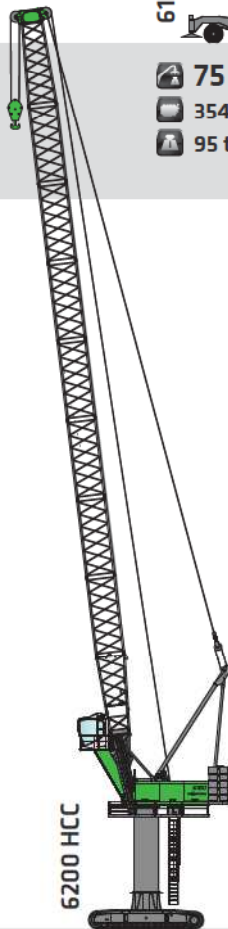

6200 HCC

180 t
400 - 570 kW
210 t

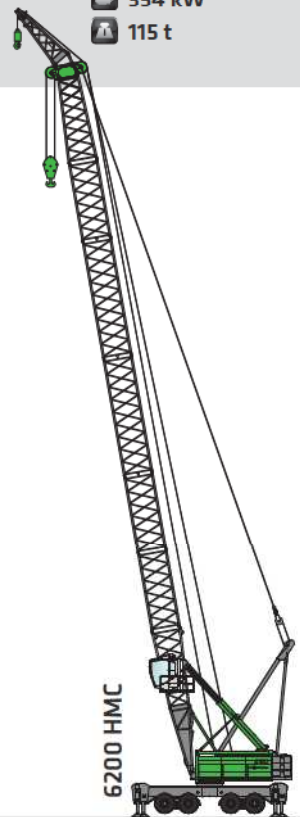

6200 HMC

100 t
400 - 470 kW
170 t



6130 HCC - 3 m Pylon - 30 m Auslegerlänge - Stahlcoil im Hakenbetrieb - Türkei
 6130 HCC - 3 m pylon - 30 m boom length - steel coil in hook operation - Turkey



6180 HCC - 7 m Pylon - 33 m Auslegerlänge - 60 Tonnen Drehhaken mit 10.000 Liter Mehrschalengreifer - Türkei
 6180 HCC - 7 m pylon - 33 m boom length - 60 tons motor swivel hook with 10,000 litre orange-peel grab - Turkey



6180 HCC - 4 m Pylon - 46,7 m Auslegerlänge - 6.500 Liter Mehrschalengreifer - Deutschland
 6180 HCC - 4 m pylon - 46,7 m boom length - 6,500 litre orange-peel grab - Germany

Kosten um 50 % senken: Elektrohydraulische Antriebe

Reduce costs by 50 %: Electro-hydraulic drives



Seit über 20 Jahren projiziert SENNEBOGEN erfolgreich elektrisch angetriebene Umschlagmaschinen und unterstreicht mit dieser Erfahrung seine Rolle als Innovationsführer.

7 Vorteile elektrohydraulischer Antriebslösungen senken die Betriebskosten gegenüber Dieselmotoren um bis zu 50 % und führen zur schnellen Amortisation der Maschine:

- Mehr Arbeitskomfort durch vibrationsfreie Antriebe und sehr geräuscharmes Arbeiten
- Hoher Werterhalt durch die längere Lebensdauer der hydraulischen Komponenten
- Sehr umweltfreundlich – absolut emissionsfrei – keine Abgase
- Sehr niedrige Betriebskosten dank geringer Energiekosten
- Wesentlich längere Service-Intervalle im Vergleich zum Dieselmotor
- Geringere Servicekosten: Entfall von Kraftstoff- und Ölfiltern/Ölwechseln
- Immer einsatzbereit – kein Betanken und keine Kraftstofflagerung erforderlich

SENNEBOGEN has been implementing material handling machines with electric drives for over 20 years and this experience underlines its status as a leader in innovation.

7 benefits of electro-hydraulic drive solutions help reduce operating costs by up to 50 % in comparison to Diesel engines and ensure that the machine pays for itself in no time:

- *Increased comfort during operation with vibration-free drives and extremely low operating noise*
- *High value retention through longer service life of the hydraulic components*
- *Extremely environmentally-friendly – completely emission-free – no exhaust fumes*
- *Extremely low operating costs thanks to low energy costs*
- *Significantly longer maintenance intervals compared with diesel engines*
- *Reduced maintenance costs: No need for fuel and oil filters/oil changes*
- *Always ready for use – no fuelling and no fuel storage required*



Zukunftsorientierte elektrohydraulische Antriebe: Sparsam, umweltfreundlich, langlebig.
Future-oriented electro-hydraulic drives: Economical, environmentally-friendly, long-living.

Prinzipdarstellung

Basic principle

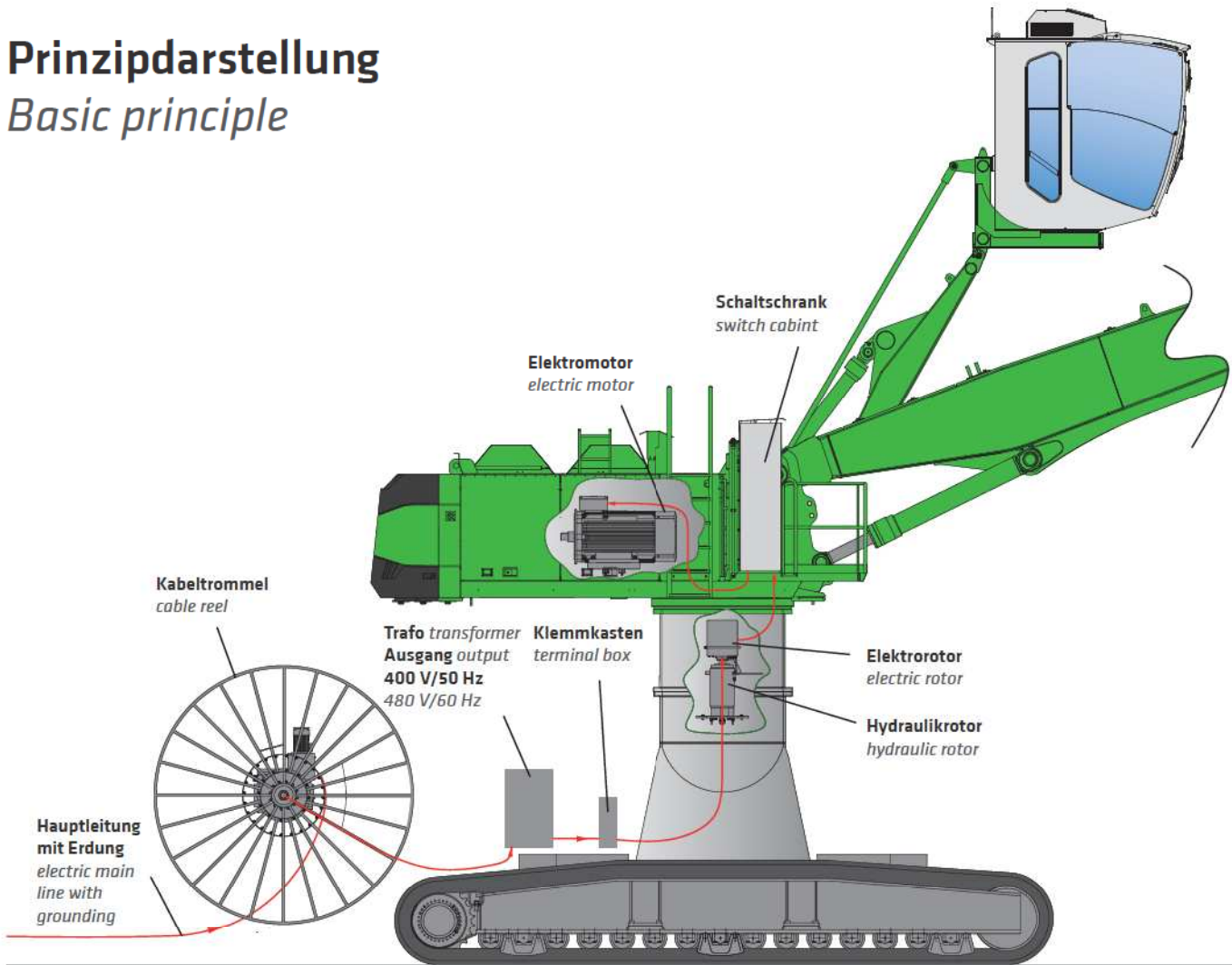

Elektroversorgung electric supply

	Feste E-Installation Fixed e-installation	Schleppkabel Trailing cable	Schleifleitung Conductor bars	Energiekette Energy chain/ power track	Motorleitungs- trommel, spiralgig motorized cable reel, monospiral	Motorleitungs- trommel, zylindrisch motorized cable reel, cylindrical
Stationäres Untergestell Stationary underframe	●					
Schienen-Unterwagen Rail undercarriage			●	●	●	●
Raupen-Unterwagen Crawler undercarriage		●	●	●	●	●
Mobil-Unterwagen Mobile undercarriage		●			●	●

● Geeignet Suitable

● Bedingt geeignet unter Einhaltung von Bedingungen, die in der Projektierung zu klären sind
Partially suitable when complying conditions that must be defined in project planning



821 mit stationär montiertem Untergestell mit fester Elektro-Installation als Energiezuführung
821 with stationary 4-point underframe with fixed electro installation



825 mit Schienenunterwagen und Pylon, Energiezuführung über Schleifleitungen und Schleifringkörper von der Hallendecke
825 with rail mounted undercarriage and slip ring body from ceiling above



850 mit stationärem Untergestell und fester Elektro-Installation als Energiezuführung
850 with stationary 4-point underframe with fixed electro installation



830 mit Raupenunterwagen und Schleppkabel als flexible Energiezuführung
830 with crawler undercarriage and trailing cable as flexible energy supply



821 mit stationär montiertem Untergestell mit fester Elektro-Installation als Energiezuführung
821 with stationary 4-point underframe with fixed electro installation



870 mit Schienenportalunterwagen und spiralig wickelnder Motorleistungstrommel als Energiezuführung
 870 with rail gantry and monospiral motorized cable reel as energy supply



830 mit Raupenunterwagen – Energiezuführung über zylindrisch wickelnde Motorleistungstrommel mit Wickeleinrichtung und Leitungseinführrichter 830 with crawler undercarriage, energy supply via cylindrical motorized cable reel with spooling device



870 mit Raupenunterwagen und Schleppkabel als Energiezuführung
 870 with crawler undercarriage and trailing cable as flexible energy supply



Mehr als 120 Vertriebs- und Servicepartner weltweit
More than 120 Sales and Service partners worldwide

Mit einem starken Netz an Vertriebs- und Servicepartnern zur Nr. 1 in Nord-Amerika
With the most successful net of sales and service partners being no. 1 in North-America

Weltweite Kundenorientierung – auch in Ihrer Nähe

Worldwide Customer Orientation – also close to you

- Mehr als 120 Vertriebspartner weltweit
 - Mehr als 300 Servicestützpunkte
 - Eigene Tochtergesellschaften und Vertretungen in den wichtigsten Schlüsselregionen
- *More than 120 sales partners worldwide*
 - *More than 300 service stations*
 - *Own subsidiaries and representative offices in the most important key regions*

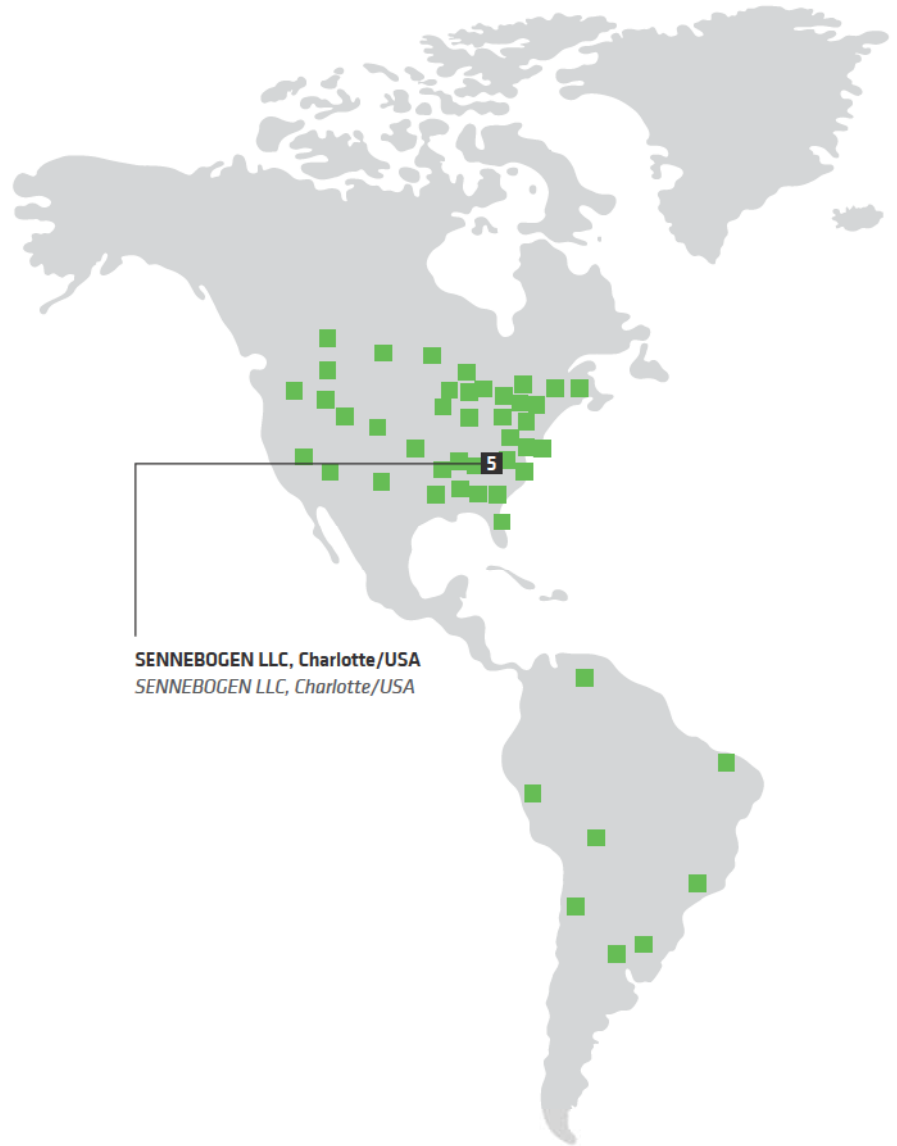

SENNEBOGEN LLC, Charlotte/USA
 SENNEBOGEN LLC, Charlotte/USA



1 Werk 1, Straubing, seit 1959, Unternehmenssitz
Works 1, Straubing, since 1959, company headquarter



2 Werk 2, Straubing Hafen, seit 2008, Produktion Großgeräte
Works 2, Straubing Port, since 2008, production large machines



3 Werk Wackersdorf, seit 1991,
Works Wackersdorf, since 1991,



Produktion auf höchstem Qualitätsniveau *Production on highest level of quality*

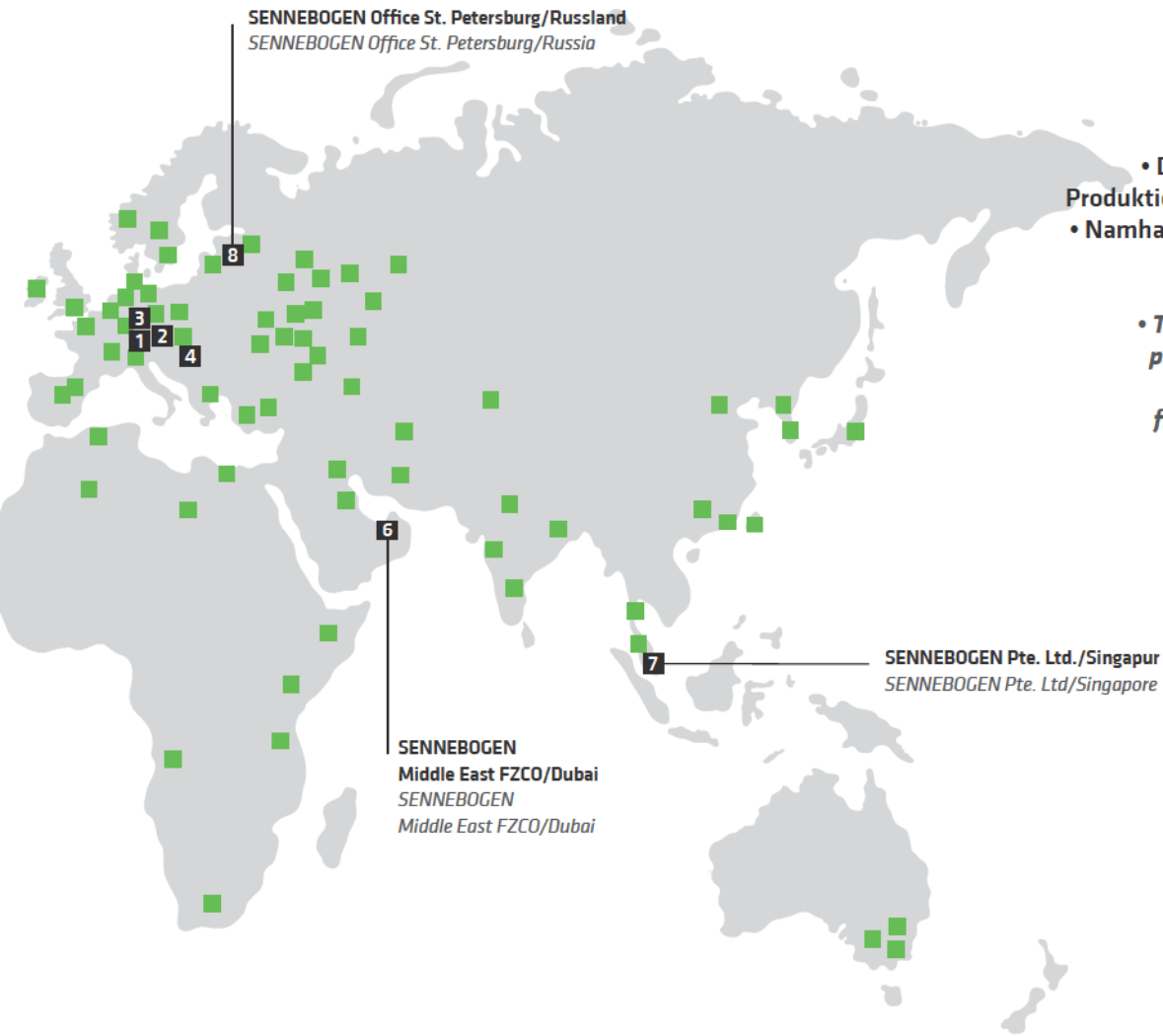

- Drei individuell ausgerichtete Produktionsstandorte in Deutschland
- Namhafte Lieferanten, hochwertige Schlüsselkomponenten
- *Three individually specialized production plants in Germany*
- *Renown suppliers deliver first-in-class key components*



3 Produktion Green Line Seriengeräte
production Green Line series machines



4 Werk Balatonfüred/Ungarn, seit 1996, Schweiß- und Stahlbaugruppen
Works Balatonfüred/Hungary, since 1996, welding/steel construction



5 SENNEBOGEN LLC, seit 2001, Vertrieb & Service Amerika
SENNEBOGEN LLC, since 2001, Sales & Service Americas

Der Kundendienst: Weltweit vor Ort

Customer Service: Wherever you are in the world



Unsere Leistung – Ihr Nutzen

- » Umfassende technische Unterstützung in allen Fragen des Gebrauchs, der Wartung und Instandsetzung unserer Maschinen
- » Gewährleistung hochgradiger Verfügbarkeit und Zuverlässigkeit unserer Maschinen durch erfahrenes Team
- » Professionelle Übergaben und Einweisungen der ausgelieferten Maschinen weltweit vor Ort
- » Hochwertige Trainings in unseren Schulungszentren in Straubing und Wackersdorf für unsere Kunden und Partner
- » Die im Feld gewonnenen Erkenntnisse fließen direkt in den kontinuierlichen Verbesserungsprozess ein

Our Performance – your benefit

- » Comprehensive technical support in all questions of usage, maintenance and repair of our machines
- » Our experienced team ensures that our machines operate reliably and with a high degree of availability
- » Professional handover and instruction on delivered machines onsite throughout the world
- » High-quality trainings in our training centers in Straubing and Wackersdorf for our customers and partners
- » The knowledge gained on site flows directly into the ongoing improvement process



Service-Center: Schnelle Ersatzteilversorgung

Service Centre: Fast provision of spare parts



Ein starker Partner für Wartung und Service

- » Schnelle Ersatzteilversorgung für unsere Maschinen sowie für das weltweite Netz an Vertriebs- und Servicepartnern über das Ersatzteil-Zentrum in Straubing
- » Mehr als 20.000 verschiedene Ersatz- und Verschleißteile auf einer Lager- und Logistikfläche von über 5.000 m²
- » Schnellstmöglicher Auftragsdurchlauf bei über 100.000 Auftragspositionen jährlich durch modernes System, Servicegrad von über 95 % bei Eilaufträgen
- » Etabliertes Transportnetzwerk mit zertifizierten Spediteuren und Logistikdienstleistern für den sicheren Luft-, See- oder Landtransport

A strong partner for maintenance and service

- » *Fast supply of spare parts for our machines and for our worldwide network of sales and service partners through the Spare Parts Centre in Straubing*
- » *More than 20,000 different spare and replacement parts on a warehousing and logistics area of over 5,000 m²*
- » *Fastest possible order processing for more than 100,000 order items a year guaranteed by our modern system, service level of over 95 % for urgent orders*
- » *Established transport network with our certified haulage contractors and logistics providers for safe delivery by air, sea or land*





Impressum:
SENNEBOGEN
Maschinenfabrik GmbH
Hebbelstraße 30
94315 Straubing
Tel. +49 94 21/540-0
Fax +49 94 21/43882
www.sennebogen.de