

 **640**

SENEBOGEN



186 kW (Stage V)



164 kW (Stage IIIa)



40 t

41.1 m



MAXCAB

640E

Heavy Duty Crawler Crane

Stage V

640E Further developed. The E-Series.



1969: First full hydraulic duty cycle crawler crane worldwide, SK 15

What makes up the E-Series

- 60 years of experience in the design and construction of duty cycle cranes
- Uncompromisingly high performance in all areas
- Technology that can be mastered: High-quality components without over-engineering
- Long service life and high value stability

Your top benefits:

1

Green Efficiency

Save fuel – reduce operating costs

Work quietly – protect operator and environment



2

Peak performance

Robust boom system – work on an incline of up to 4°

3

Maximum usability

Comfortable Maxcab operator cab – relaxed work

SENCON – work program selection made easy



4

Flexibility in service

Operate under full load – less space required

Strong undercarriage traction – good off-road capability

5

Easy transport

Mobile undercarriage with outrigger – ready to go in no time

6

Maintenance and service made easy

SENNEBOGEN control system – easy error diagnostics

Simple maintenance – clear labeling

7

Consultation and support in your area

3 production sites – 2 subsidiaries

130 sales partners – over 350 service stations

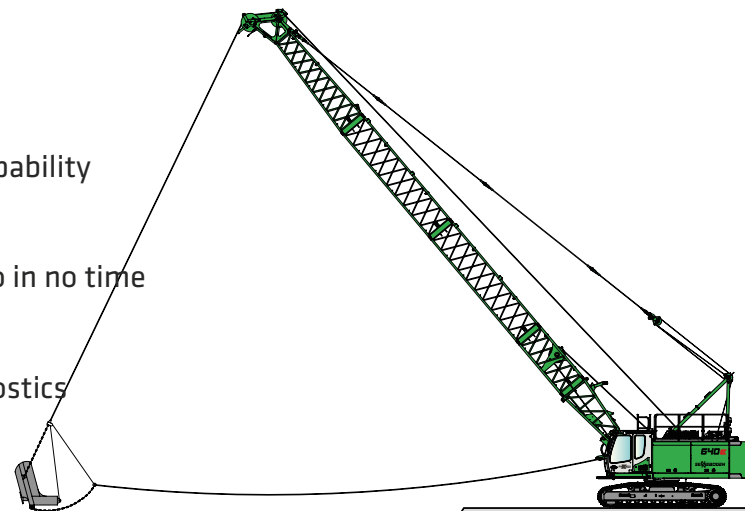

Dragline bucket equipment

640E

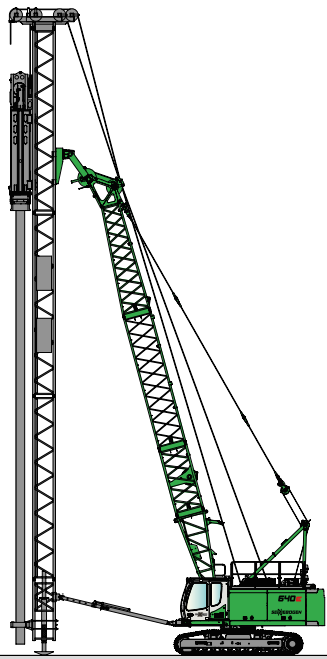

Leader

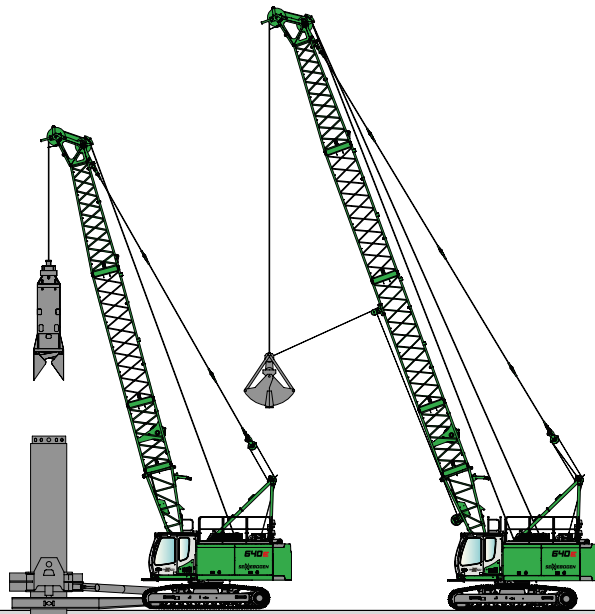

Casing oscillator

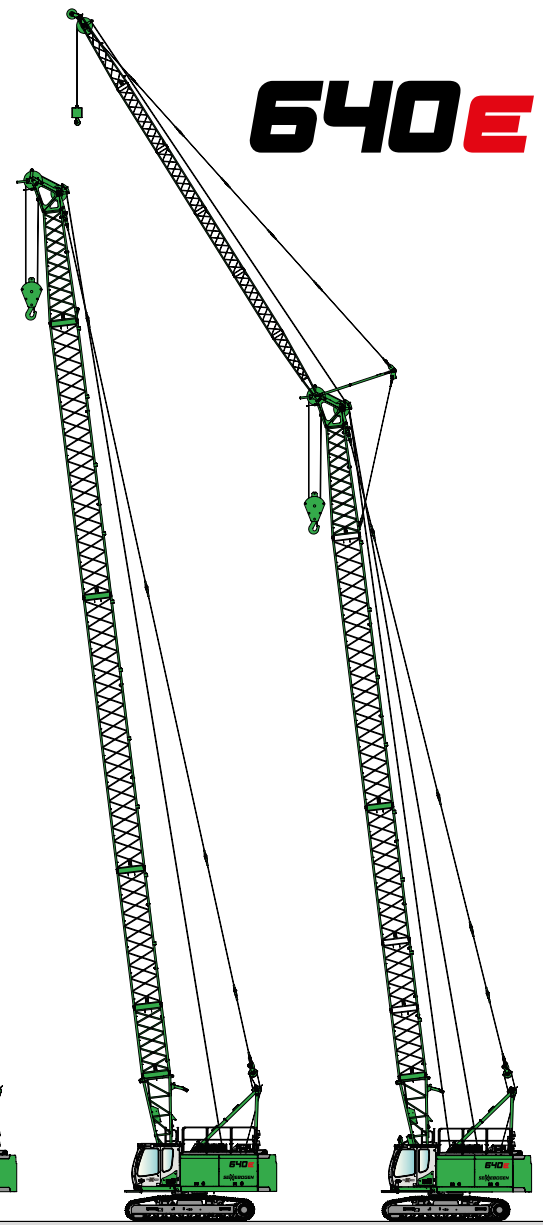

Crane equipment

Crane equipment with fixed fly

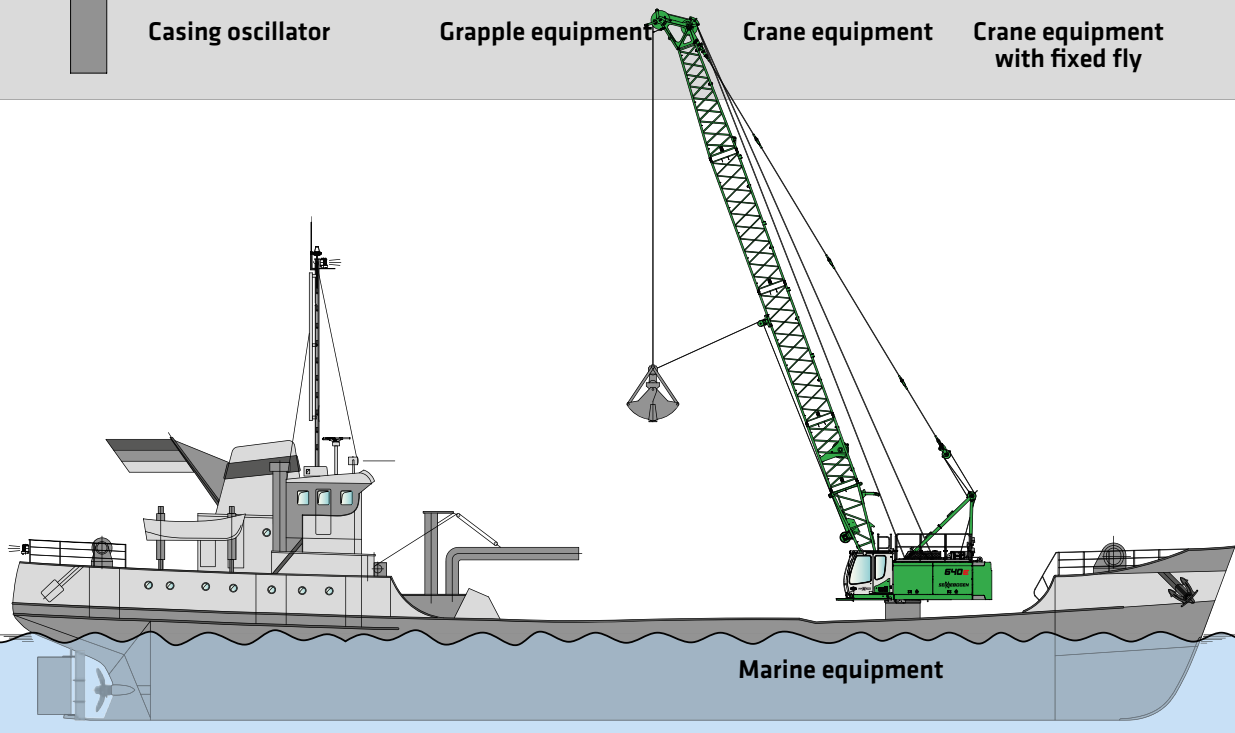

Marine equipment

MACHINE TYPE

Model (type) **640**

ENGINE

Power **186 kW / 253 HP at 1800 rpm**
164 kW / 223 HP at 2000 rpm

Model **Cummins B 6.7 Stage V**
Cummins QSB 6.7 Stage IIIa
Direct injection, turbo-charged, charge air cooler, reduced emissions

Cooling Water-cooled

Air filter Dry filter with pre-separator, automatic dust discharge, main element and safety element, contamination indicator

Fuel tank **450 l**

Electr. system **24 V**

Batteries **2 x 150 Ah**, main switch

UPPERCARRIAGE

Design Torsion-resistant box design, precision crafted, bronze bushings for boom bearing arrangement
Clear, service-friendly concept, engine installed in the longitudinal direction

Lighting LED spotlights for optimal illumination of the work area

Safety Camera monitoring of the rear area and right side

Options

- Maritime climate paint finish as corrosion protection
- Low-temperature package for work deployments at temperatures under -20°C
- Ballast support fixture
- Automatic pinion tooth lubrication for slewing ring, outer
- Automatic central lubrication system for equipment and slewing ring, inner
- Walkways left and right on the uppercarriage

HYDRAULIC SYSTEM

Multi-circuit hydraulic system for optimal function and capacity, running all movements simultaneously is possible. The hydraulic pumps are variable displacement piston pumps with individual control and energy-saving flow-on-demand control. The pumps only request as much oil as is actually consumed. Pressure cut-off, load limit sensing control

Delivery rate **maximum 3 x 220 l/min**

Operating pressure **to 330 bar**

Filtration High-performance filtration with long-term change interval, contamination level indicator

Hydraulic tank **550 l (450 l to the middle of the sight glass)**

Control system Proportional, precision hydraulic servo controllers of work movements, 2 hydraulic servo joysticks for work functions, supplemental functions via switches and foot pedals – arranged clearly and ergonomically

Options

- Bio-oil filling
- SENNEBOGEN HydroClean micro-filter system with water separator
- Potentiometer for casing machine and other attachments
- Grapple fill automation
- Supplemental hydraulic system with 1 x 220 l/min

SLEWING DRIVE

Gearbox Compact planetary gear with slant axis hydraulic motor, integrated brake valves – positioner slewing gear brake

Parking brake Spring-loaded disk brake

Slewing ring Ball bearing rotary connection with exterior gearing

Slewing speed 0-4, rpm, 3 adjustable slewing speeds

Option

- 2nd slewing gear for increased slewing moment

CAB

Cab type Maxcab rigid

Cab equipment Sliding door, excellent ergonomics, climate automation, seat heater, air-suspension comfort seat, fresh air filter / circulating air filter, joystick steering, 12 V / 24 V USB connections, SENCON, roof window, sliding windows on the driver's side

Options

- Cab type E270, can be elevated 270 cm
- Cab can be tilted 15°
- Auxiliary heating system with timer
- Cabs with active carbon filter inside/outside air
- Armored-glass windshield
- Armored-glass sunroof
- Safety side window and rear window
- Sunblind for windshield
- Protective roof grating
- FOPS protective roof grating
- Protective front grating
- Radio with speakers
- electrical cooler

ATTACHMENTS

Design	Decades of experience and the latest computer simulations guarantee the greatest degree of stability and longest service life.
Boom adjustment winch	Drive via slant axis hydraulic motor with compact planetary gear, pulling force 52 kN, rope diameter 14 mm, adjustment speed 30° to 80° in approx. 40 seconds.
Safety brake	Spring-loaded disk brake
Boom	Boom length 41.1 m
Options	<ul style="list-style-type: none"> ■ Auxiliary jib, for safe working loads to 12 t ■ Fixed fly to 18 m ■ Steel rope sheaves ■ Jib sheaves for grapple implementation ■ HD sheaves for working with optimal rope guide ■ Boom damping, hydraulic ■ Load moment limitation for hoisting implementation: Latest generation of load moment monitoring, Display shows all important data, lifting limit switch, pressure relief valves, rope run-out safeguard ■ roll mask

UNDERCARRIAGE

Design	Extremely strong crawler undercarriage, type T41/380 with hydraulically extensible track width. Stable welded construction.
Drive	Strong travel drive with axial piston hydraulic motor and directly attached automatically functioning brake valve and compact planetary gear per each running gear side; protected drive transmission
Parking brake	Spring-loaded disk brake
Traveling gear	Maintenance-free tractor running gear B60 with hydraulic chain tension, 700 mm 3-grouser base plates,
Speed	0 – 2.0 km/h
Options	<ul style="list-style-type: none"> ■ 700 mm flat base plates (transport width 3000 mm) ■ 800 mm flat base plates (transport width 3200 mm) ■ 800 mm 3-grouser base plates (transport width 3200 mm) ■ Tractor running gear B6 with increased traction force

WINCH

The winches are driven via high-pressure regulated adjustable hydraulic motors, thus there is always optimal pulling force speed control. Hydraulic lowering brake valves for sensitive, wear-free braking. Strong oil bath, planetary gear, low-maintenance.

Crane brake and free-fall brake are spring-loaded, maintenance-free, low-wear disc brakes running in the oil bath, oil-cooled. The individual, variably adjustable free-fall brake actively support the operator, prevents slack cable and protects the machine

	Series production	Option
Winches	12 t	16 t
Rope winch (rated load)		
1st layer	120 kN	160 kN
Rope diameter	22 mm	26 mm
Rope speed	0-125 m/min	0-120 m/min
Options	<ul style="list-style-type: none"> ■ Grapple steadying winch 9 kN ■ Grapple steadying winch 18 kN ■ Grapple steadying winch 30 kN ■ rope tensioning pulley 	

OPERATING WEIGHT

Mass	approximately 40,000 kg
Note	640 HD with 2 x 12 t freefall winches, basic boom 10.3 m, counterweight 8.2 t, 40 t bottom hook block, 700 mm 3-grouser base plates, 125 m hoisting rope
	The operating weight varies depending on version and equipment.

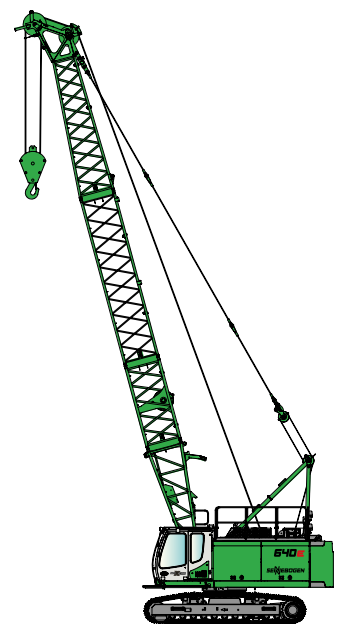

640E Main boom



HD

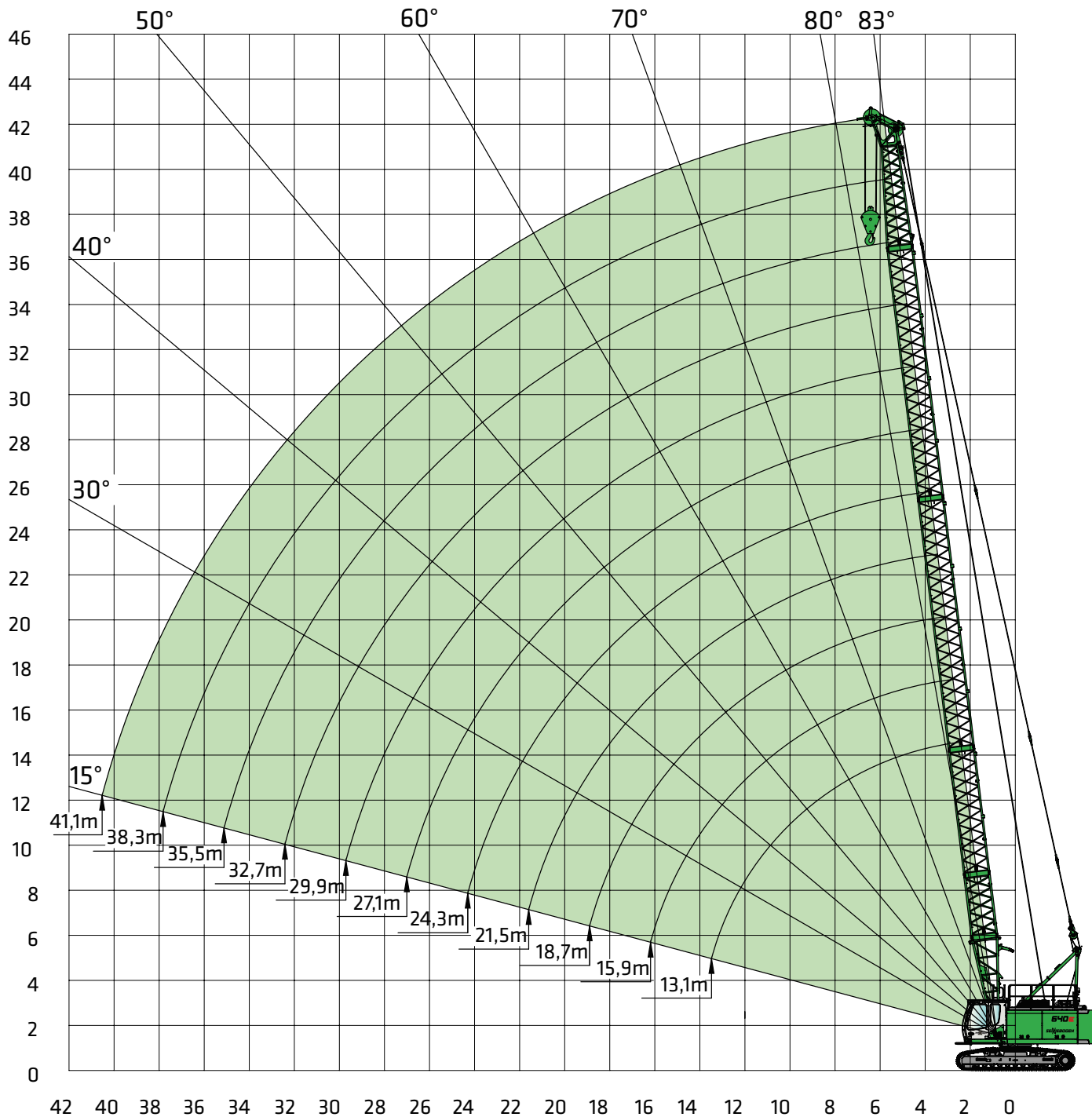

Boom configuration

	Boom length	10.3	13.1	15.9	18.7	21.5	24.3	27.1	29.9	32.7	35.5	38.3	41.1
Lower boom section, type 1370	4.4 m	1	1	1	1	1	1	1	1	1	1	1	1
Intermediate boom section, type 1370 (DL) *	2.8 m	0	0 (1)	0 (1)	0 (1)	0 (1)	0 (1)	0	0	0	0	0	0
Intermediate boom section, type 1370	2.8 m	0	1 (0)	2 (1)	1 (0)	2 (1)	1 (0)	2	1	2	1	2	1
Intermediate boom section, type 1370	5.6 m	0	0	0	1	1	2	2	1	1	2	2	1
Intermediate boom section, type 1370	11.2 m	0	0	0	0	0	0	0	1	1	1	1	2
Boom headpiece, type 1370	5.9 m	1	1	1	1	1	1	1	1	1	1	1	1
Auxiliary jib S12.5, type 1370 (option)	12.0 t	x	x	x	x	x	x	x	x	x	x	x	x

* The 2.8 m boom section, type 1370 (DL) is only required for dragline bucket implementation, values in () apply for dragline bucket operation

 8.2 t	Boom length [m]												
	10.3	13.1	15.9	18.7	21.5	24.3	27.1	29.9	32.7	35.5	38.3	41.1	
Working radius [m]													
2.6	40.0												
3.0	40.0	40.0	39.8/3.3	32.8/3.6									
4.0	35.8	33.2	31.1	29.1	27.4	23.9/4.3	20.6/4.7						
5.0	25.8	24.8	23.5	22.4	21.2	20.2	19.3	18.5	16.3/5.4	14.8/5.7			
6.0	19.2	19.1	18.9	18.0	17.2	16.5	15.8	15.2	14.6	14.0	13.5	12.2/6.4	
7.0	15.2	15.1	15.0	15.0	14.4	13.9	13.4	12.9	12.4	12.0	11.5	11.1	
8.0	12.5	12.4	12.3	12.3	12.2	11.9	11.5	11.1	10.7	10.3	10.0	9.6	
9.0	10.6	10.5	10.4	10.3	10.2	10.2	10.0	9.7	9.4	9.1	8.7	8.5	
10.0	9.2	9.1	8.9	8.9	8.8	8.8	8.6	8.6	8.3	8.0	7.7	7.5	
11.0	8.2/10.9	7.9	7.8	7.8	7.6	7.6	7.5	7.5	7.4	7.2	6.9	6.7	
12.0		7.1	6.9	6.9	6.7	6.7	6.6	6.6	6.5	6.4	6.2	6.0	
13.0		6.3	6.2	6.1	6.0	6.0	5.9	5.8	5.7	5.6	5.5	5.4	
14.0		6.0/13.6	5.6	5.5	5.4	5.4	5.2	5.2	5.1	5.0	4.9	4.8	
15.0			5.1	5.0	4.9	4.8	4.7	4.7	4.6	4.5	4.4	4.3	
16.0			4.6	4.6	4.4	4.4	4.3	4.2	4.1	4.0	3.9	3.8	
17.0			4.5/16.3	4.2	4.0	4.0	3.9	3.8	3.7	3.6	3.5	3.5	
18.0				3.9	3.7	3.7	3.5	3.5	3.4	3.3	3.2	3.1	
19.0				3.6	3.4	3.4	3.2	3.2	3.1	3.0	2.9	2.8	
20.0					3.2	3.1	3.0	2.9	2.8	2.7	2.6	2.5	
22.0					2.8/21.7	2.7	2.5	2.5	2.4	2.3	2.1	2.1	
24.0						2.3	2.2	2.1	2.0	1.9	1.8	1.7	
26.0						2.2/24.4	1.9	1.8	1.7	1.6	1.5	1.4	
28.0							1.7/27.1	1.6	1.4	1.3	1.2	1.1	
30.0								1.4/29.8	1.2	1.1	1.0	0.9	
32.0									1.1	0.9	0.8	0.7	
34.0									1.0/32.5	0.8	0.7	0.6	
36.0										0.7/35.2	0.5	0.4	
38.0	TABLE no. 640R-80/1965/8.2/04.14 SH											0.4	0.3
Strand number	Ø 26 mm	4	4	4	3	3	2	2	2	2	2	2	2
	Ø 22 mm	5	5	5	4	4	3	3	3	2	2	2	2

Comments:

- The specified safe working load values apply for level and stable stance of the machine.
- The safe working load values are specified in tons (t) and apply for 360 degrees.
- The safe working loads take the standards ISO 4305 Tab. 1+2, and the tilt angle method (tilt angle 4°) into account
- Deduct the weight of the load handling devices (hook, suspension gear) from the safe working loads.
- The safe working loads apply for the maximum undercarriage track width of 3800 mm.
- The safe working load values must be limited or reduced in order to take unfavorable conditions into account, such as soft or uneven ground, inclined slopes, wind, lateral forces, swinging loads, jerking or sudden stopping of the load, inexperience of the personnel or driving with a load.
- Permissible rope winch per strand in crane operation for rope diameter at 26 mm - 12,000 kg
at rope diameter 22 mm - 8500 kg
- Safe working loads apply for the SH boom (boom assembly in accordance with the operating manual)
- Safe working loads apply for optimum boom assembly and a pulley head with plastic pulleys.
- The specified safe working load values are only for orientation. See the operating manual for the respectively valid safe working loads.

Auxiliary jib S12.5

maximum hoisting capacity 12.0 t
(rope diameter 26 mm)
or maximum hoisting capacity 8.5 t
(rope diameter 22 mm)

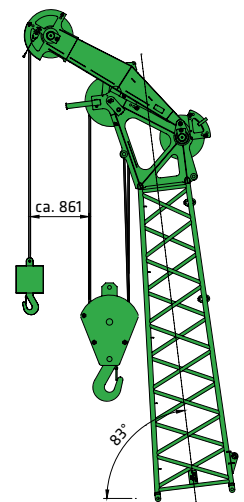

640E Fixed fly boom

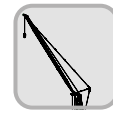

HD

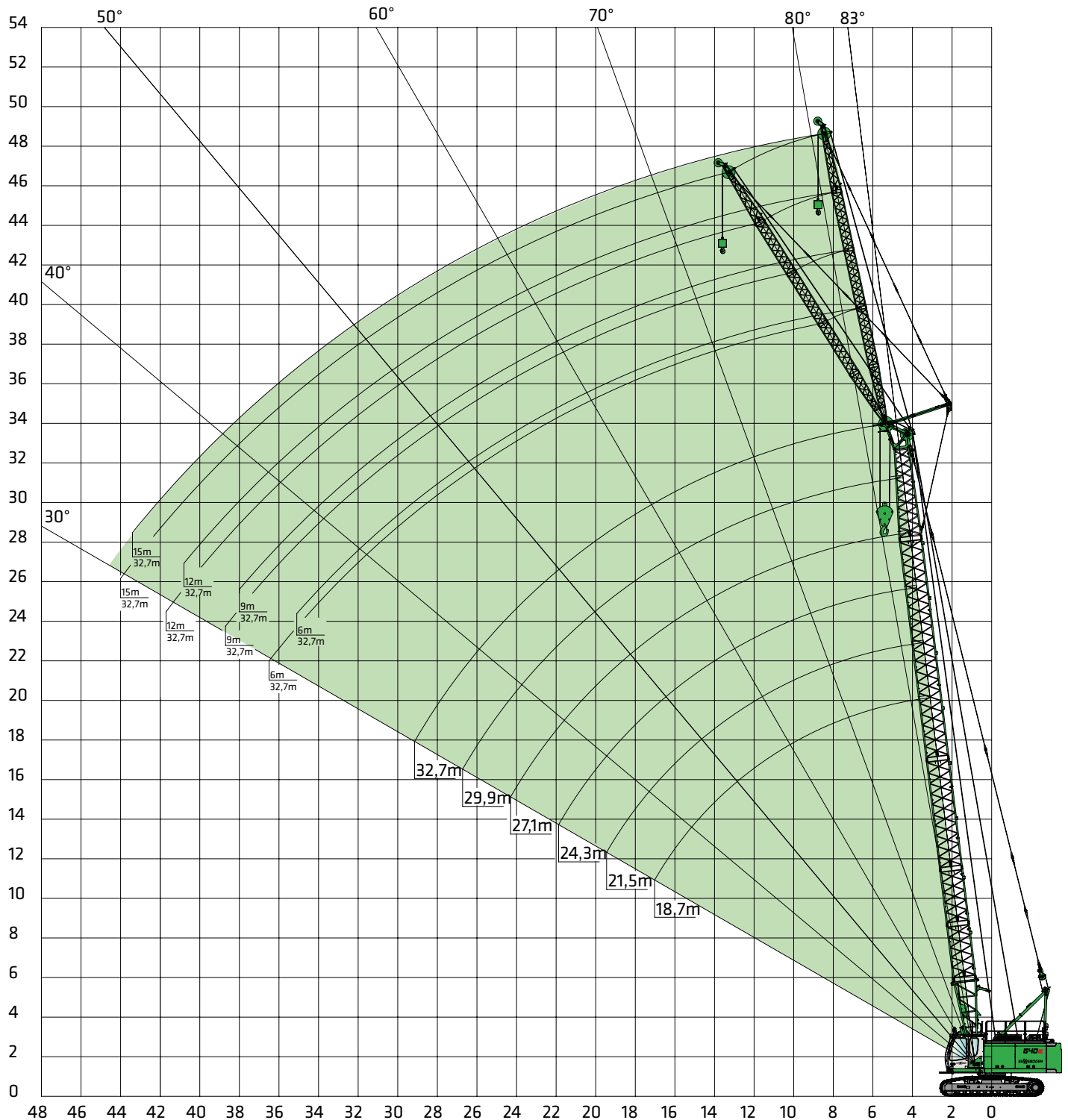

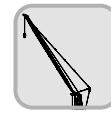

 8.2 t 5° Working radius [m]	Main boom length [m]																												
	18.7					21.5					24.3					27.1					29.9					32.7			
	Fly boom length [m]																												
	6.0	9.0	12.0	15.0	18.0	6.0	9.0	12.0	15.0	18.0	6.0	9.0	12.0	15.0	18.0	6.0	9.0	12.0	15.0	18.0	6.0	9.0	12.0	15.0	18.0	6.0	9.0	12.0	15.0
5.0	12.0/5.2					12.0/5.5					12.0/5.9																		
6.0	12.0	11.6/6.2	8.8/6.9			12.0	11.5/6.5				12.0	11.2/6.9				12.0/6.2					12.0/6.6						11.8/6.9		
7.0	12.0	11.4	8.8	6.6/7.4	5.3/7.7	12.0	11.4	8.5/7.3	6.5/7.8		12.0	11.2	8.3/7.6			12.0	10.9/7.2				12.0	10.6/7.6					11.6	10.1/7.9	
8.0	12.0	11.1	8.5	6.6	5.2	11.6	11.1	8.4	6.4	5.2	11.2	11.0	8.2	6.3/8.1	5.1/8.4	10.8	10.6	8.1	6.1/8.5	5.0/8.7	10.5	10.3	7.8/8.3	5.9/8.8		10.1	10.0	7.6/8.6	
9.0	10.4	10.4	8.3	6.4	5.2	10.2	10.0	8.2	6.3	5.1	9.8	9.7	8.0	6.2	5.0	9.5	9.4	7.9	6.0	5.0	9.2	9.1	7.7	5.9	4.9	8.9	8.8	7.5	5.7/9.1
10.0	8.9	9.0	8.1	6.2	5.1	8.8	8.9	8.1	6.2	5.0	8.7	8.6	7.8	6.1	5.0	8.4	8.3	7.8	5.9	4.9	8.1	8.1	7.6	5.9	4.8	7.9	7.8	7.4	5.6
11.0	7.8	7.9	7.8	6.1	5.0	7.7	7.8	7.8	6.1	4.9	7.6	7.7	7.5	6.0	4.9	7.5	7.4	7.3	5.9	4.8	7.3	7.2	7.1	5.8	4.7	7.0	7.0	6.9	5.6
12.0	6.9	7.0	7.0	5.9	4.9	6.8	6.9	6.9	5.9	4.8	6.7	6.8	6.8	5.9	4.8	6.6	6.7	6.6	5.8	4.7	6.5	6.5	6.4	5.7	4.7	6.3	6.3	6.2	5.5
13.0	6.1	6.2	6.3	5.8	4.8	6.0	6.1	6.2	5.8	4.8	5.9	6.0	6.1	5.8	4.7	5.8	5.9	6.0	5.7	4.7	5.8	5.9	5.8	5.6	4.6	5.7	5.7	5.6	5.4
14.0	5.5	5.6	5.6	5.6	4.7	5.4	5.5	5.5	5.5	4.7	5.3	5.4	5.4	5.5	4.6	5.2	5.3	5.4	5.4	4.6	5.1	5.2	5.3	5.2	4.5	5.0	5.2	5.1	5.0
15.0	5.0	5.0	5.1	5.1	4.6	4.9	4.9	5.0	5.0	4.6	4.8	4.9	4.9	4.9	4.6	4.7	4.8	4.8	4.8	4.5	4.6	4.7	4.8	4.8	4.5	4.5	4.6	4.7	4.6
16.0	4.5	4.6	4.6	4.6	4.5	4.4	4.5	4.5	4.5	4.5	4.3	4.4	4.4	4.5	4.4	4.2	4.3	4.3	4.4	4.3	4.2	4.2	4.3	4.3	4.3	4.1	4.2	4.2	4.2
17.0	4.1	4.2	4.2	4.2	4.2	4.0	4.1	4.1	4.1	4.1	3.9	4.0	4.0	4.1	4.0	3.8	3.9	3.9	4.0	3.9	3.8	3.8	3.9	3.9	3.9	3.7	3.7	3.8	3.8
18.0	3.8	3.8	3.9	3.9	3.9	3.7	3.7	3.8	3.8	3.8	3.6	3.7	3.7	3.7	3.7	3.5	3.5	3.6	3.6	3.6	3.4	3.5	3.5	3.5	3.5	3.3	3.4	3.4	3.5
19.0	3.5	3.5	3.6	3.6	3.6	3.4	3.4	3.5	3.5	3.5	3.3	3.3	3.4	3.4	3.4	3.2	3.2	3.3	3.3	3.3	3.1	3.2	3.2	3.2	3.2	3.0	3.1	3.1	3.1
20.0	3.2	3.3	3.3	3.3	3.3	3.1	3.2	3.2	3.2	3.2	3.0	3.1	3.1	3.1	3.1	2.9	3.0	3.0	3.0	3.0	2.8	2.9	2.9	3.0	2.9	2.7	2.8	2.9	2.9
22.0	2.8	2.8	2.8	2.8	2.8	2.6	2.7	2.7	2.7	2.7	2.5	2.6	2.6	2.6	2.6	2.4	2.5	2.5	2.5	2.5	2.4	2.4	2.5	2.5	2.5	2.3	2.3	2.4	2.4
24.0	2.6/23.0	2.4	2.5	2.5	2.4	2.3	2.3	2.4	2.4	2.3	2.2	2.2	2.3	2.3	2.2	2.1	2.1	2.2	2.2	2.1	2.0	2.1	2.1	2.1	2.1	1.9	2.0	2.0	2.0
26.0		2.1/25.9	2.1	2.2	2.1	2.0/25.4	2.0	2.0	2.0	2.0	1.9	1.9	1.9	1.9	1.9	1.7	1.8	1.8	1.8	1.8	1.7	1.7	1.8	1.8	1.8	1.6	1.6	1.7	1.7
28.0			1.9	1.9	1.9		1.7	1.8	1.8	1.8	1.6/27.8	1.6	1.7	1.7	1.7	1.5	1.5	1.6	1.6	1.6	1.4	1.5	1.5	1.5	1.5	1.3	1.4	1.4	1.4
30.0			1.8/28.6	1.7	1.6		1.7/28.3	1.5	1.5	1.5		1.4	1.4	1.4	1.4	1.3	1.3	1.3	1.3	1.3	1.2	1.2	1.3	1.3	1.3	1.1	1.1	1.2	1.2
32.0				1.5/31.3	1.4			1.4/31.1	1.3	1.3		1.3/30.7	1.2	1.2	1.2	1.2/30.3	1.1	1.1	1.1	1.1	1.0	1.1	1.1	1.1	1.1	0.9	0.9	1.0	1.0
34.0					1.3/33.9				1.2/33.7	1.2			1.1/33.5	1.1	1.1		1.0/33.1	1.0	1.0	0.9	0.9/32.7	0.9	0.9	0.9	0.9	0.7	0.8	0.8	0.8
36.0										1.0				0.9	0.9			0.8/35.9	0.8	0.8		0.7/35.6	0.7	0.7	0.7	0.6/35.1	0.6	0.6	0.6
38.0										1.0/36.3				0.9/36.2	0.8				0.7	0.7			0.6	0.6	0.6		0.5	0.5	0.5
40.0															0.7/38.7				0.6/38.6	0.5			0.6/38.3	0.5	0.5			0.4	0.4
42.0																				0.5/41.1				0.4/41.0	0.4			0.3/40.8	0.3
44.0																								0.3/43.6					0.2/43.4
44.0	TABLE no. 640R-80/1965/08.2/04.14 SHF55																												
Number of strands	1	1	1	1	1	1	1	1	1	1	1	1	1	1	1	1	1	1	1	1	1	1	1	1	1	1	1	1	1

Comments:

- The specified safe working load values apply for level and stable stance of the machine.
- The safe working load values are specified in tons (t) and apply for 360 degrees.
- The safe working loads take the standards ISO 4305 Tab. 1+2, and the tilt angle method (tilt angle 4°) into account
- Deduct the weight of the load handling devices (hook, suspension gear) from the safe working loads.
- The safe working loads apply for the maximum undercarriage track width.
- The working load values must be limited or reduced in order to take unfavorable conditions into account, such as soft or uneven ground, inclined slopes, wind, lateral forces, swinging loads, jerking or sudden stopping of the load, inexperience of the personnel or driving with a load.
- Permissible rope winch per strand in crane operation for rope diameter at 26 mm – 12,000 kg at rope diameter 22 mm – 8,500 kg
- Safe working loads apply for the SHFS boom (boom assembly in accordance with the operating manual)
- Safe working loads apply for optimum boom assembly and a pulley head with plastic pulleys.

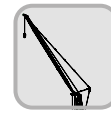

 8.2 t	Main boom length [m]																													
	18.7					21.5					24.3					27.1					29.9					32.7				
	Fly boom length [m]																													
Working radius [m]	6.0	9.0	12.0	15.0	18.0	6.0	9.0	12.0	15.0	18.0	6.0	9.0	12.0	15.0	18.0	6.0	9.0	12.0	15.0	18.0	6.0	9.0	12.0	15.0	18.0	6.0	9.0	12.0	15.0	
5.0																														
6.0																														
7.0	12.0/7.2					12.0/7.5					11.9/7.8																			
8.0	11.9	8.7/8.9				11.9					11.9					10.9/8.2						10.2/8.5					9.3/8.9			
9.0	10.8	8.7				10.5	8.6/9.2				10.2	8.6/9.6				9.8	8.5/9.9					9.5					9.2			
10.0	9.3	8.6	6.2/10.4			9.2	8.6	6.2/10.8			9.0	8.5				8.7	8.5					8.5	8.2/10.3				8.2	7.7/10.6		
11.0	8.1	8.3	6.2	4.7/11.7		8.0	8.3	6.2			7.9	8.1	6.1/11.1			7.8	7.8	6.1/11.4				7.6	7.6	6.0/11.8			7.3	7.4		
12.0	7.1	7.3	6.1	4.7	3.9/12.8	7.0	7.3	6.1	4.6		7.0	7.2	6.1	4.6/12.4		6.9	7.0	6.1	4.5/12.7			6.8	6.9	6.0			6.6	6.7	6.0/12.1	
13.0	6.3	6.6	6.1	4.6	3.9	6.3	6.5	6.1	4.5	3.9/13.1	6.2	6.4	6.0	4.5	3.8/13.4	6.1	6.4	6.0	4.5	3.8/13.8	6.1	6.2	6.0	4.5			5.9	6.0	5.9	4.5/13.4
14.0	5.7	5.9	6.0	4.5	3.8	5.6	5.8	6.0	4.5	3.8	5.6	5.8	5.9	4.5	3.8	5.5	5.7	5.9	4.5	3.8	5.4	5.7	5.7	4.4	3.7/14.2	5.4	5.5	5.5	4.5	
15.0	5.2	5.3	5.5	4.4	3.8	5.1	5.3	5.4	4.4	3.8	5.0	5.2	5.4	4.4	3.7	4.9	5.1	5.3	4.4	3.7	4.9	5.1	5.3	4.4	3.7	4.8	5.0	5.1	4.4	
16.0	4.7	4.8	5.0	4.4	3.7	4.6	4.8	4.9	4.4	3.7	4.5	4.7	4.9	4.4	3.7	4.4	4.6	4.8	4.4	3.7	4.4	4.6	4.8	4.4	3.7	4.3	4.5	4.6	4.4	
17.0	4.3	4.4	4.6	4.3	3.6	4.2	4.3	4.5	4.3	3.6	4.1	4.3	4.4	4.3	3.6	4.0	4.2	4.4	4.3	3.6	4.0	4.2	4.3	4.4	3.6	3.9	4.1	4.2	4.3	
18.0	3.9	4.1	4.2	4.2	3.6	3.8	4.0	4.1	4.2	3.6	3.7	3.9	4.0	4.2	3.6	3.7	3.8	4.0	4.1	3.6	3.6	3.8	3.9	4.0	3.6	3.5	3.7	3.9	4.0	
19.0	3.6	3.7	3.8	3.9	3.5	3.5	3.6	3.8	3.9	3.5	3.4	3.6	3.7	3.8	3.5	3.3	3.5	3.6	3.7	3.6	3.3	3.5	3.6	3.7	3.5	3.2	3.4	3.5	3.6	
20.0	3.3	3.4	3.6	3.6	3.4	3.2	3.4	3.5	3.6	3.5	3.1	3.3	3.4	3.5	3.5	3.1	3.2	3.3	3.4	3.5	3.0	3.2	3.3	3.4	3.5	2.9	3.1	3.2	3.3	
22.0	2.8	2.9	3.0	3.1	3.2	2.7	2.9	3.0	3.1	3.1	2.7	2.8	2.9	3.0	3.1	2.6	2.7	2.8	2.9	3.0	2.5	2.7	2.8	2.9	2.9	2.4	2.6	2.7	2.8	
24.0	2.5/23.5	2.5	2.6	2.7	2.8	2.3	2.4	2.5	2.6	2.7	2.3	2.4	2.5	2.6	2.6	2.2	2.3	2.4	2.5	2.5	2.1	2.2	2.4	2.4	2.5	2.0	2.2	2.3	2.4	
26.0		2.2	2.3	2.4	2.4	2.0	2.1	2.2	2.3	2.3	1.9	2.0	2.1	2.2	2.3	1.8	1.9	2.0	2.1	2.2	1.8	1.9	2.0	2.1	2.1	1.7	1.8	1.9	2.0	
28.0		2.1/26.5	2.0	2.1	2.1		1.8	1.9	2.0	2.0	1.7	1.7	1.8	1.9	2.0	1.6	1.7	1.7	1.8	1.9	1.5	1.6	1.7	1.8	1.8	1.4	1.5	1.6	1.7	
30.0			1.8/29.5	1.8	1.8		1.7/29.0	1.6	1.7	1.8	1.6/28.4	1.5	1.6	1.6	1.7	1.3	1.4	1.5	1.6	1.6	1.3	1.4	1.4	1.5	1.6	1.2	1.3	1.4	1.4	
32.0				1.6	1.6			1.4	1.5	1.5		1.3/31.4	1.3	1.4	1.5	1.2/30.8	1.2	1.3	1.3	1.4	1.1	1.1	1.2	1.3	1.3	1.0	1.0	1.1	1.2	
34.0				1.5/32.5	1.4				1.3	1.3			1.1	1.2	1.3		1.0/33.8	1.1	1.1	1.2	0.9/33.3	0.9	1.0	1.1	1.1	0.8	0.9	0.9	1.0	
36.0					1.3/35.4				1.2/34.9	1.1			1.1/34.4	1.0	1.1			0.9	0.9	1.0		0.8	0.8	0.9	0.9	0.6	0.7	0.8	0.8	
38.0										1.0/37.8					0.9/37.4	0.9		0.8/36.8	0.8	0.8		0.8/36.3	0.7	0.7	0.8	0.6/36.5	0.5	0.6	0.6	
40.0															0.8			0.6/39.8	0.7			0.6/39.2	0.6	0.6		0.5/38.7	0.5	0.5	0.5	
42.0														0.7/40.3						0.5				0.5	0.5			0.3/41.7	0.4	
44.0																				0.5/42.7				0.4/42.2	0.4				0.3	
46.0																										0.3/45.2				
Number of strands	1	1	1	1	1	1	1	1	1	1	1	1	1	1	1	1	1	1	1	1	1	1	1	1	1	1	1	1	1	

Comments:

- The specified safe working load values apply for level and stable stance of the machine.
- The safe working load values are specified in tons (t) and apply for 360 degrees.
- The safe working loads take the standards ISO 4305 Tab. 1+2, and the tilt angle method (tilt angle 4°) into account
- Deduct the weight of the load handling devices (hook, suspension gear) from the safe working loads.
- The safe working loads apply for the maximum undercarriage track width.
- The working load values must be limited or reduced in order to take unfavorable conditions into account, such as soft or uneven ground, inclined slopes, wind, lateral forces, swinging loads, jerking or sudden stopping of the load, inexperience of the personnel or driving with a load.
- Permissible rope winch per strand in crane operation for rope diameter at 26 mm – 12,000 kg at rope diameter 22 mm – 8,500 kg
- Safe working loads apply for the SHFS boom (boom assembly in accordance with the operating manual)
- Safe working loads apply for optimum boom assembly and a pulley head with plastic pulleys.

Main boom with fixed fly SHFS

		Boom configuration										
		Main boom						Fixed fly jib				
Boom length		18.7	21.5	24.3	27.1	29.9	32.7	6.0	9.0	12.0	15.0	18.0
Lower boom section, type 1370	4.4 m	1	1	1	1	1	1					
Intermediate boom section, type 1370	2.8 m	1	2	1	2	1	2					
Intermediate boom section, type 1370	5.6 m	1	1	2	2	1	1					
Intermediate boom section, type 1370	11.2 m	0	0	0	0	1	1					
Boom headpiece, type 1370	5.9 m	1	1	1	1	1	1					
Fly boom lower section, type 598	3.0 m							1	1	1	1	1
Fly boom intermediate section, type 598	3.0 m							0	1	2	3	4
Fly boom head piece, type 598	3.0 m							1	1	1	1	1

Combination possibilities SHFS

		Boom configuration					
Length fixed fly		Main boom					
		18.7	21.5	24.3	27.1	29.9	32.7
6.0 m		x	x	x	x	x	x
9.0 m		x	x	x	x	x	x
12.0 m		x	x	x	x	x	x
15.0 m		x	x	x	x	x	x
18.0 m		x	x	x	x	x	



Hooks

For 120 kN winches with 22 mm rope diameter

Capacity	Weight	Rope strands and maximum safe working load [kg]					
		6	5	4	3	2	1
10 t	200 kg						8,500
25 t 1-pulley	300 kg				25,000	17,000	8,500
40 t 2-pulley	350 kg		40,000	34,000	25,500	17,000	8,500

For 160 kN winches with 26 mm rope diameter

Capacity	Weight	Rope strands and maximum safe working load [kg]					
		6	5	4	3	2	1
15 t	300 kg						12,000
40 t 1-pulley	500 kg				36,000	24,000	12,000
60 t 2-pulley	600 kg			40,000	36,000	24,000	12,000

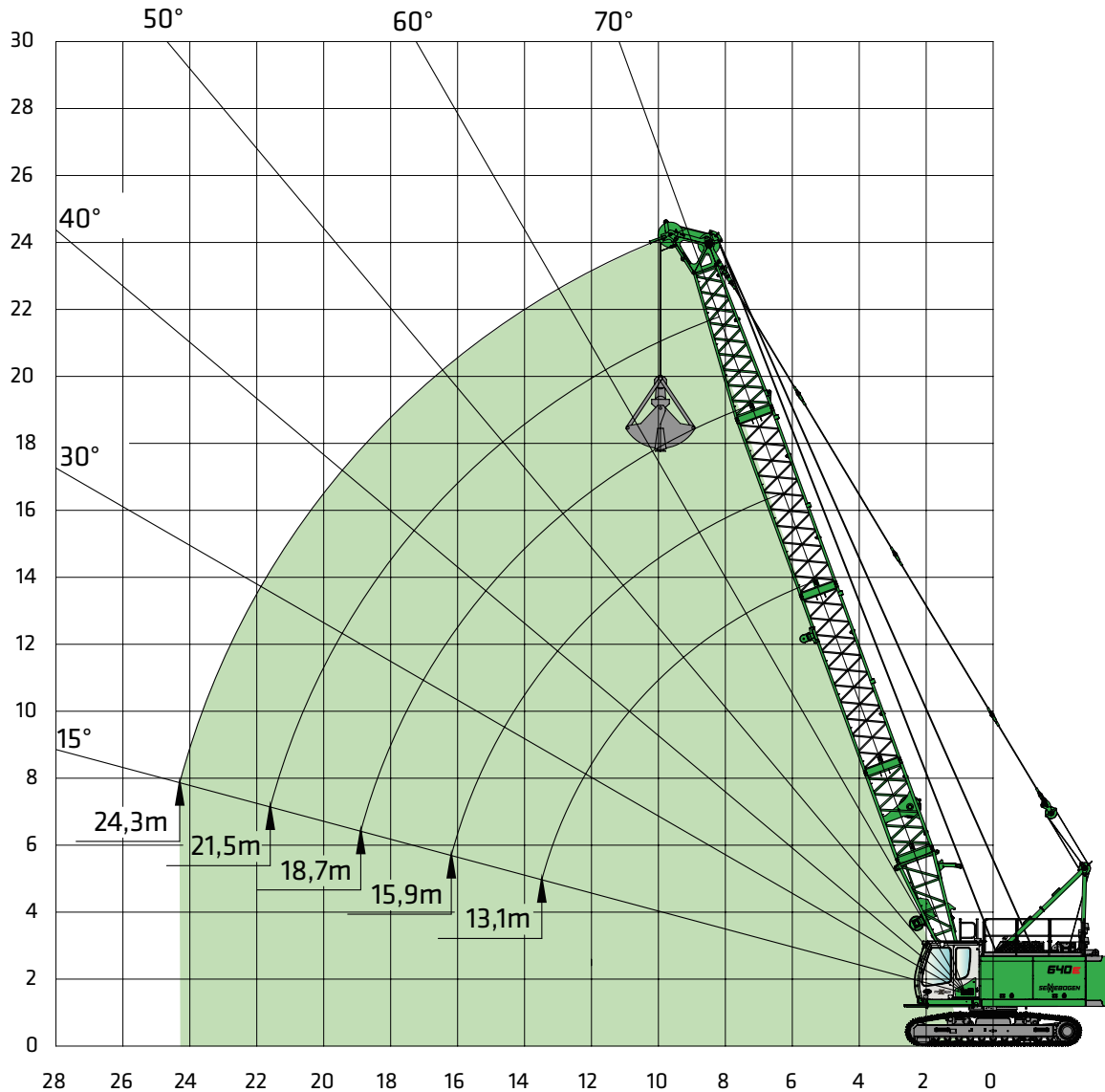

Comments:

1. The specified safe working load values apply for level and stable stance of the machine.
2. The safe working load values are specified in tons (t) and apply for 360 degrees.
3. The safe working loads apply for the maximum outrigger width undercarriage track width of 3800 mm
4. The specified safe working loads include the grapple weight and do not exceed 66.7% of the tipping load
5. For operation with a mechanical two-rope grapple, the safe working load is limited by the permissible rope tension or the maximum winch pulling force of a winch.

Winch pulling force [kN]	160	120
Rope diameter [mm]	26	22
Minimum tensile strength [kN]	568	426
Permissible rope winch [t]	16.0	12.0

8.2 t	Boom length [m]														
	13.1			15.9			18.7			21.5			24.3		
	R	H	t	R	H	t	R	H	t	R	H	t	R	H	t
70	5.8	13.8	16.9	6.8	16.4	13.3	7.7	19.0	10.9	8.7	21.7	9.1	9.6	24.3	7.7
65	6.8	13.3	13.1	8.0	15.8	10.3	9.2	18.4	8.4	10.4	20.9	7.0	11.6	23.4	5.9
60	7.8	12.7	10.7	9.2	15.1	8.4	10.6	17.6	6.9	12.0	20.0	5.7	13.4	22.4	4.8
55	8.8	12.1	9.1	10.4	14.4	7.1	12.0	16.6	5.8	13.6	18.9	4.8	15.2	21.2	4.0
50	9.7	11.3	8.0	11.5	13.5	6.2	13.3	15.6	5.0	15.1	17.8	4.1	16.9	19.9	3.4
45	10.5	10.5	7.1	12.4	12.5	5.6	14.4	14.5	4.5	16.4	16.5	3.6	18.4	18.4	3.0
40	11.2	9.6	6.5	13.3	11.4	5.0	15.5	13.2	4.0	17.6	15.0	3.3	19.8	16.8	2.7
35	11.9	8.7	6.0	14.2	10.3	4.6	16.5	11.9	3.7	18.7	13.5	3.0	21.0	15.1	2.4
30	12.4	7.7	5.6	14.9	9.1	4.3	17.3	10.5	3.4	19.7	11.9	2.7	22.1	13.3	2.2
25	12.9	6.7	5.4	15.5	7.9	4.1	18.0	9.1	3.3	20.5	10.2	2.6	23.1	11.4	2.1
20	13.3	5.6	5.1	16.0	6.6	3.9	18.6	7.5	3.1	21.2	8.5	2.5	23.8	9.4	2.0
15	13.6	4.5	5.0	16.3	5.2	3.8	19.0	6.0	3.0	21.7	6.7	2.4	24.4	7.4	1.9

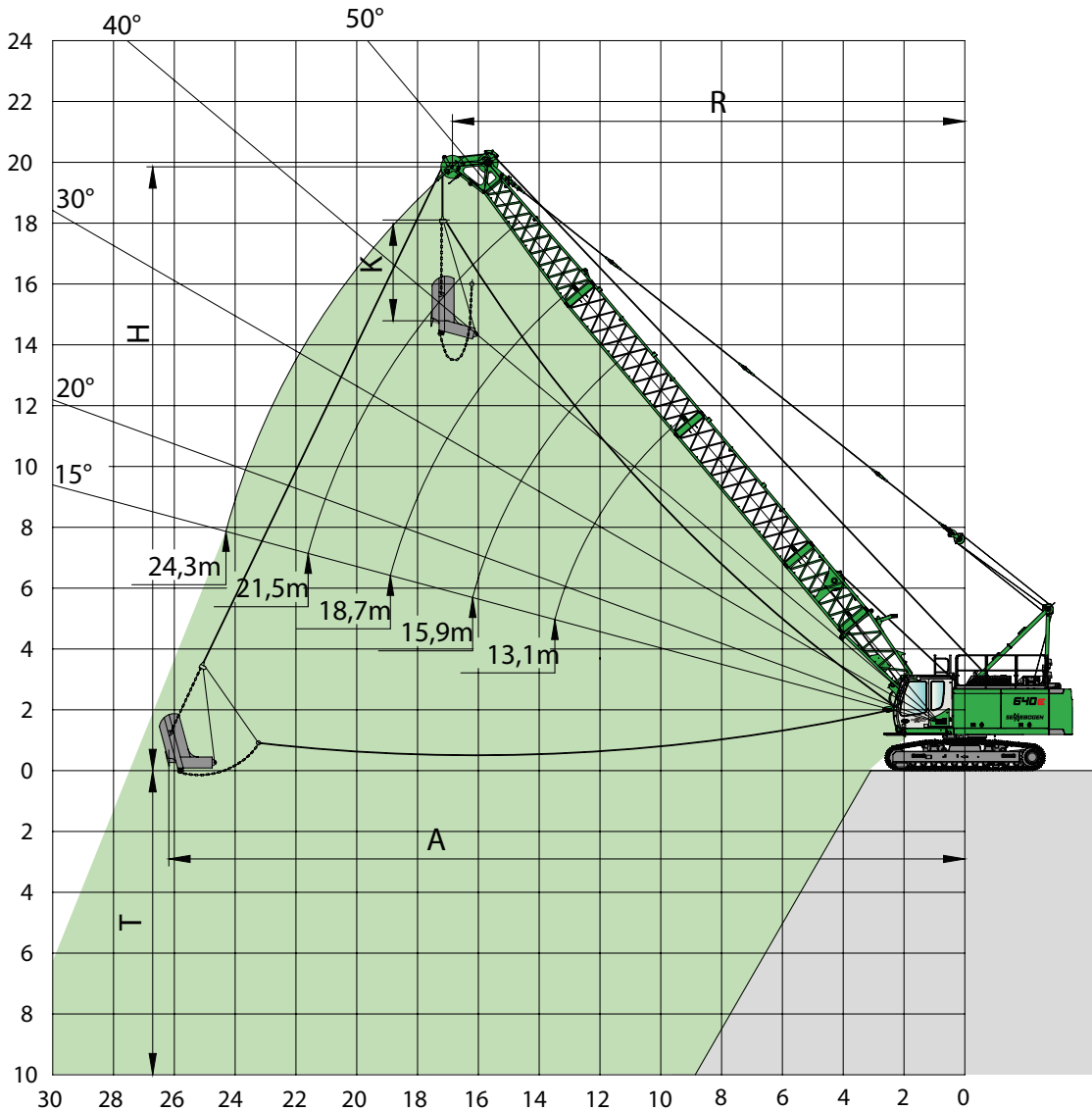

Comments:

1. The specified safe working load values apply for level and stable stance of the machine.
2. The safe working load values are specified in tons (t) and apply for 360 degrees.
3. The safe working loads apply for the maximum outrigger width undercarriage track width of 3800 mm.
4. The specified safe working loads include the grapple weight and do not exceed 75% of the tipping load.
5. Motor and winch equipment as required (the specified values apply for maximum equipment and average conditions).
6. The dragline bucket size must be configured in accordance with the given conditions.
 Dredging arc:
 R = Working radius
 A = Maximum dredging width = approximately $R + 1/3$ to $1/2 (H-K)$
 T = Dredging depth = approximately 40-50% of R
 H = Height
 K = Length of the dragline bucket

 8.2 t	Boom length [m]														
	13.1			15.9			18.7			21.5			24.3		
	R	H	t	R	H	t	R	H	t	R	H	t	R	H	t
Boom angle alpha [°]	m	m	t	m	m	t	m	m	t	m	m	t	m	m	t
50	9.7	11.3	8.9	11.5	13.5	6.9	13.3	15.6	5.6	15.1	17.8	4.6	16.9	19.9	3.8
45	10.5	10.5	7.9	12.4	12.5	6.2	14.4	14.5	4.9	16.4	16.5	4.0	18.4	18.4	3.3
40	11.2	9.6	7.2	13.3	11.4	5.6	15.5	13.2	4.5	17.6	15.0	3.6	19.8	16.8	2.9
35	11.9	8.7	6.7	14.2	10.3	5.1	16.5	11.9	4.1	18.7	13.5	3.3	21.0	15.1	2.7
30	12.4	7.7	6.2	14.9	9.1	4.8	17.3	10.5	3.8	19.7	11.9	3.0	22.1	13.3	2.4
25	12.9	6.7	5.9	15.5	7.9	4.5	18.0	9.1	3.6	20.5	10.2	2.8	23.1	11.4	2.3
20	13.3	5.6	5.7	16.0	6.6	4.3	18.6	7.5	3.4	21.2	8.5	2.7	23.8	9.4	2.2
15	13.6	4.5	5.5	16.3	5.2	4.2	19.0	6.0	3.3	21.7	6.7	2.6	24.4	7.4	2.1

640E Dimensions

HD

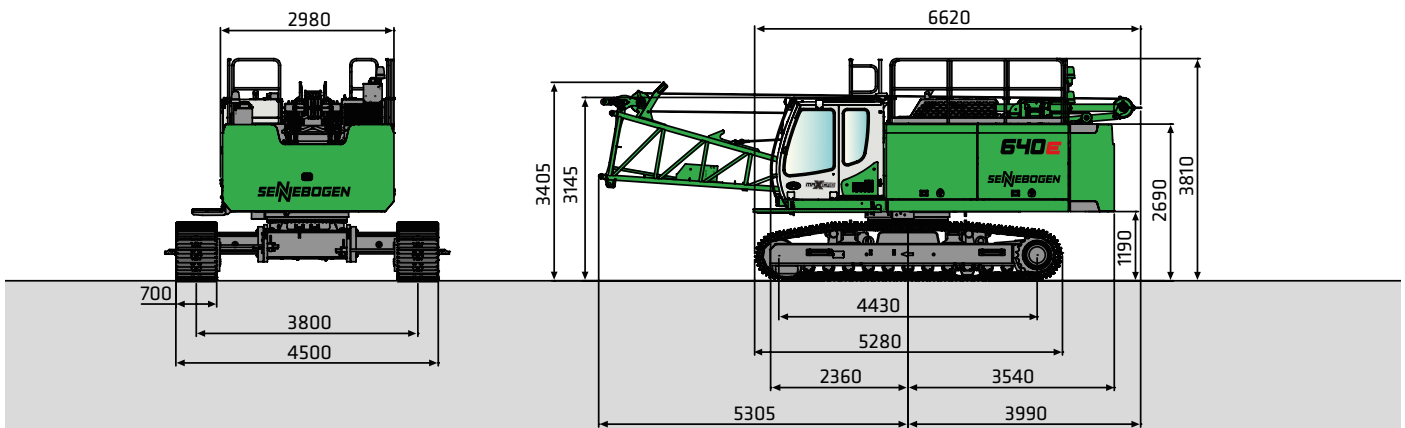

640 HD with counterweight 8.2 t, telescopic undercarriage T41/380, lower boom section 2 x 12 t freetail winch approx 38,700 kg

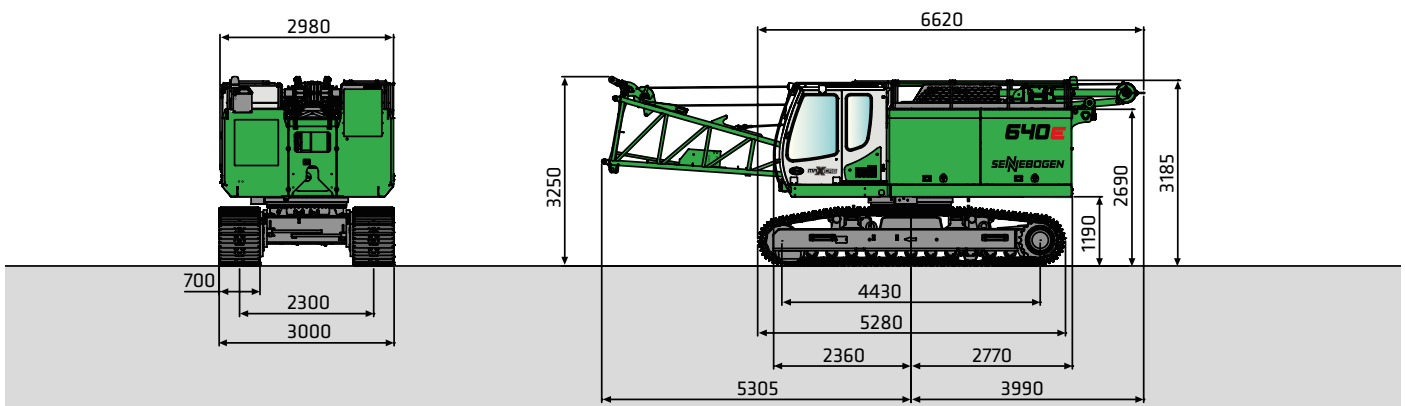

640 HD without counterweight, lower boom section 2 x 12 t freetail winch, approx. 30,500 kg

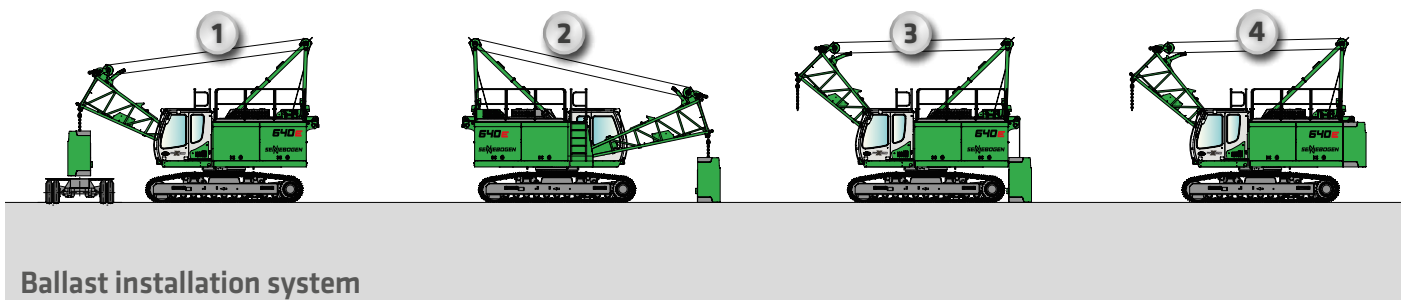

Ballast installation system

	Lower boom section 4.4 m, type 1370
Weight: 850 kg (maximum 1,300 kg)	
	Intermediate boom section 2.8 m, type 1370 (DL) with deflection sheave for dragline bucket operation
Weight: 710 kg (incl. holding ropes)	
	Intermediate boom section 2.8 m, type 1370
Weight: 300 kg (incl. holding ropes)	
	Intermediate boom section 5.6 m, type 1370 with deflection sheave for dragline bucket operation
Weight: 490 kg (incl. holding ropes)	
	Intermediate boom section 11.2 m, type 1370
Weight: 870 kg (incl. holding ropes)	
	Boom head piece 5.9 m, type 1370
steel pulleys: 1120 kg (incl. holding ropes) plastic pulleys: 960 kg (incl. holding ropes)	
	Auxiliary jib S12.5
Weight: 280 kg	
	Counterweight
Weight: 8200 kg	
	Lower boom section 3 m, type 598
Weight: 330 kg	
	Intermediate boom section 3 m, type 598
Weight: 120 kg (incl. holding ropes)	
	Boom headpiece 3 m, type 598
Weight: 210 kg (incl. holding rope)	

640E

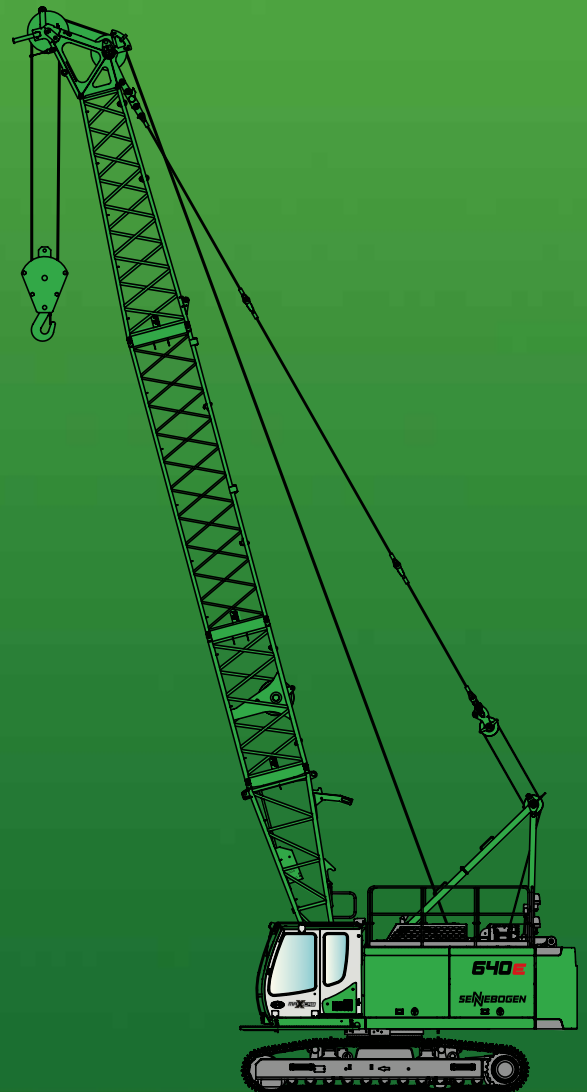

This catalog describes machine models, scopes of equipment of individual models, and configuration options (standard equipment and optional equipment) of the machines delivered by SENNEBOGEN Maschinenfabrik. Machine illustrations can contain optional equipment and supplemental equipment. Actual equipment may vary in a tolerance range depending on the country to which the machines are delivered, especially in regard to standard and optional equipment

All product designations used may be trademarks of SENNEBOGEN Maschinenfabrik GmbH or other supplying companies, and any use by third parties for their own purposes may violate the rights of the owners.

Please contact your local SENNEBOGEN sales partner for information concerning the equipment variants offered. Requested performance characteristics are only binding if they are expressly stipulated upon conclusion of the contract. Delivery options and technical features are subject to change. Errors and omissions excepted. Equipment is subject to change, and rights of advancement are reserved.

© SENNEBOGEN Maschinenfabrik GmbH, Straubing/Germany. Reproduction in whole or in part only with written consent of SENNEBOGEN Maschinenfabrik GmbH, Straubing, Germany.

SENNEBOGEN

SENNEBOGEN
Maschinenfabrik GmbH
Sennebogenstrasse 10
94315 Straubing, Germany

Tel. +49 9421 540-144/146
marketing@sennebogen.de

Order no. / Item no. 187543
640HD-E-031510-101615-011905

GO FOR GREEN

 www.sennebogen.com