



# Telescopic Cranes

## Teleskopkrane

**Flexibility & Mobility on the highest level**  
*Flexibilität & Mobilität auf höchstem Niveau*

**SE NEBOGEN**



01



02



03



04



05

# Content

## Inhalt

### 01 OVER 65 YEARS EXPERIENCE

#### Über 65 Jahre Erfahrung

- 6 **100% Family-run company**  
*100 % Familienunternehmen*
- 8 **Chronicle Cranes since 1952**  
*Chronik: Krane seit 1952*

### 02 QUALITY MADE BY SENNEBOGEN

#### Qualität made by SENNEBOGEN

- 10 **SENNEBOGEN - Made in Germany**
- 12 **The right machine for every job**  
*Die richtige Maschine für jeden Einsatz*

### 03 OUR TELESCOPIC CRANES

#### UNSERE TELESKOPKRANE

- 14 **Product overview**  
*Produktübersicht*
- 16 **The main advantage of a Telescopic Crawler Crane**  
*Ein Teleskopkran definiert sich über...*
- 18 **Ready to use in 10 minutes**  
*Einsatzbereit in 10 Minuten*
- 19 **Lift loads securely even on inclines**  
*Lasten sicher heben auch in Schräglage*
- 20 **Move loads horizontally and vertically**  
*Lasten horizontal & vertikal bewegen*
- 21 **Suitable for the toughest terrain**  
*Besteht im schwersten Gelände*
- 22 **Full-Power Boom for max. flexibility**  
*Full-Power Boom für max. Flexibilität*
- 23 **Excellent reliability**  
*Hervorragende Zuverlässigkeit*
- 24 **Individual operator`s place**  
*Der individuelle Fahrerplatz*
- 26 **Compact dimensions**  
*Kompakt in den Abmessungen*
- 27 **Modular design for numerous options**  
*Modular konstruiert - viele Optionen*

### 04 MACHINE OVERVIEW

#### Maschinenübersicht

- 28 **613 M Telescopic Mobile Crane**  
*613 M Mobil-Teleskopkran*
- 34 **643 M Telescopic Mobile Crane**  
*643 M Mobil-Teleskopkran*
- 40 **683 M Telescopic Mobile Crane**  
*683 M Mobil-Teleskopkran*
- 44 **6113 M Telescopic Mobile Crane**  
*6113 M Mobil-Teleskopkran*
- 46 **613 R Telescopic Crawler Crane**  
*613 R Raupen-Teleskopkran*
- 52 **633 R Telescopic Crawler Crane**  
*633 R Raupen-Teleskopkran*
- 54 **643 R Telescopic Crawler Crane**  
*643 R Raupen-Teleskopkran*
- 60 **653 R Telescopic Crawler Crane**  
*653 R Raupen-Teleskopkran*
- 66 **673 R Telescopic Crawler Crane**  
*673 R Raupen-Teleskopkran*
- 72 **683 R Telescopic Crawler Crane**  
*683 R Raupen-Teleskopkran*
- 78 **6113 R Telescopic Crawler Crane**  
*6113 R Raupen-Teleskopkran*
- 84 **Customized - Special applications**  
*Kunden-/Sonderlösungen*

### 05 SERVICE AND TRAINING

#### Service und Training

- 58 **SENNEBOGEN Expert Training**  
*SENNEBOGEN Expertentraining*
- 59 **SENTRACK**  
*SENTRACK*
- 60 **Worldwide customer orientation**  
*Weltweite Kundenorientierung*



# SENNEBOGEN Telescopic Cranes - Flexibility & Mobility on the highest level

*SENNEBOGEN Teleskopkrane -  
Flexibilität & Mobilität auf höchstem Niveau*



# 100 % Family-run company



## Nearly 30 years experience in design and construction of telescopic cranes

*Nahezu 30 Jahre Erfahrung in der Konstruktion und im Bau von Teleskopkranen*

What do you expect from a telescopic crane? Exactly the same as you can expect from us as a company: Quality, reliability and customized solutions - Made in Germany. Over the past 65 years, this is what SENNEBOGEN stands for - you can rely on our experience!

*Was erwarten Sie von einem Teleskopkran? Das was Sie auch von uns als Unternehmen erwarten dürfen: Qualität, Zuverlässigkeit und individuelle Problemlösungen - Made in Germany. Dafür steht das Familienunternehmen SENNEBOGEN seit über 65 Jahren - vertrauen Sie auf unsere Erfahrung!*

Erich Sennebogen Snr. overcame any obstacle with his motto: "There's no such thing as can't."

*Hindernisse überwand Erich Sennebogen sen. mithilfe seines Credos: „Es geht nicht, gibt's nicht.“*



**Family-run company for generations**  
*Familiengeführtes Unternehmen seit Generationen*

# 100 % Familienunternehmen



**Management with visions (from left to right): Erich Sennebogen, Walter Sennebogen, Thorsten Resch, Veronika Meier**  
*Geschäftsleitung mit Weitblick (von links nach rechts): Erich Sennebogen, Walter Sennebogen, Thorsten Resch, Veronika Meier*



**Works 1, Straubing: Company headquarter**  
*Werk 1, Straubing: Unternehmenssitz*



**SENNEBOGEN Service Center: Straubing**  
*SENNEBOGEN Service Center: Straubing*



**Works 2, Straubing Port: Production of large machines**  
*Werk 2, Straubing Hafen: Produktion Großgeräte*



**SENNEBOGEN Academy, Straubing**  
*SENNEBOGEN Akademie, Straubing*



**Works Wackersdorf: Production of Green Line series machines**  
*Werk Wackersdorf: Produktion Green Line Seriengeräte*



**Works Balantonfüred, Hungary: Welding/steel structures**  
*Werk Balantonfüred/Ungarn: Schweiß-/Stahlbaugruppen*



**SENNEBOGEN LLC: Sales and Service, USA**  
*SENNEBOGEN LLC: Verkauf und Service USA*

# Expertise in Lattice Boom and Telescopic Cranes

## *Erfahrung mit Gittermast- und Telekranen seit 1952*



1952



1976



1972



1968



1992

1952

Since the company was founded by Erich Sennebogen in 1952 we have been successfully making history in lifting and material handling

*Seit der Firmengründung 1952 durch Erich Sennebogen schreiben wir erfolgreich Geschichte in der Hebe- und Umschlagtechnik*

1972

SK 15 fully hydraulic mobile crane with luffing jib

*SK 15 vollhydraulischer Mobilkran mit Wippspitze*

1976

612 M a successful model with boom folding device

*612 M ein Erfolgsmodell mit klappbarem Ausleger*

1992

613 M as an allround wheeled crane with hook, working platform and lifting forks

*613 M als Universal Mobilkran mit Kranhaken, Arbeitsbühne und Hubgabel*



since 1952



1995



2006



2013



The 6113 is the new flagship in the telescopic crawler crane sector with a lifting capacity of 120 t

*Der 6113 bildet das neue Flaggschiff im Bereich der Raupentelekrane mit 120 t Traglast*

1995

630 HD telescopic crawler crane emphasizes the company's leading status in this crane sector

*630 HD Raupentelekrane unterstreicht den führenden Anspruch in diesem Kransegment*

2005

The multicrane 608 defines a totally new class of all-round construction crane

*Der Multicrane 608 definiert einen völlig neuen Allround Baustellenkran*

2006

With a lifting capacity of 80 t, the 683 mobile telescopic crane is a new innovation in industrial cranes.

*Mit 80 t Traglast ist der mobile Teleskopkran 683 ein Novum als Industriekran*

2013

673 R: with 20 years of expertise in building telescopic crawler cranes, SENNEBOGEN launches the 70 t crane

*673 R: Mit 20 Jahren Kompetenz im Bau von Raupentelekranen bringt SENNEBOGEN den 70 Tonne auf den Markt*



# SENNEBOGEN

## Made in Germany



### Over 65 years of experience

*Über 65 Jahre Erfahrung*

- decades of experience in development and construction of Duty Cycle Cranes and Telescopic Cranes
- wide product range with 11 different Telescopic Cranes
- worldwide delivery to 50 countries across all continents
- Jahrzehntelange Erfahrung in der Entwicklung und Konstruktion von Seilbaggern und Kranen
- Breites Produktportfolio mit 11 unterschiedlichen Telekranen
- Lieferungen in 50 Ländern weltweit auf alle Kontinente



### Quality Made in Germany

*Qualität Made in Germany*

- 3 production plants in Bavaria/Germany
- 1.400 experienced and qualified professional employees all over the world
- best quality for excellent durability of our machines with high resale value
- 3 Produktionswerke in Bayern/Deutschland
- 1.400 erfahrene und qualifizierte Fachkräfte weltweit
- beste Qualität für hohe Langlebigkeit unserer Maschinen mit hohem Wiederverkaufswert



### Reliability

*Zuverlässigkeit*

- simple and manageable technology
- avoidance of over-engineering: Keep it simple!
- excellent components secure a maximum of value retention
- einfache und beherrschbare Technik
- Vermeidung von Over-Engineering: Keep it simple!
- Beste Komponenten für maximale Wertstabilität



### Worldwide Customer Orientation

*Weltweites Vertriebsnetz*

- more than 150 international sales and service partners
- experienced and trained service partners for all interests in customer service
- fast supply of spare parts and fast on-site service
- *Über 150 Vertriebs- und Servicepartner weltweit*
- *Erfahrene und geschulte Servicepartner für alle Belange im Kundendienst*
- *Schnelle Ersatzteilversorgung und schneller Vor-Ort-Service*



### Highest flexibility

*Höchste Flexibilität*

- customer-specific solutions are one of the greatest strengths of SENNEBOGEN for decades
- modular solutions assure a flexible adaption also on your wishes
- modular solutions assure a flexible adaption also on your wishes
- *Kundenspezifische Speziallösungen sind seit Jahrzehnten eine ausgeprägte Stärke von SENNEBOGEN*
- *modulare Baukastenlösungen gewährleisten eine flexible Anpassung auch auf Ihre individuellen Anforderungen.*

# The right machine for every job

*Die richtige Maschine für jeden Einsatz*



**Industry & municipalities**  
*Industrie & Kommunal*



**Pipe installation works**  
*Rohrlegearbeiten*



**Tunnel construction**  
*Tunnelbau*



**Bridge building**  
*Brückenbau*



**Maintenance**  
*Instandhaltung*



**Structural engineering**  
*Hochbau*



**Offshore**



**Hydraulic engineering**  
*Wasserbau*



**Civil engineering**  
*Tiefbau*



**Wind power**  
*Windkraft*



**Demolition & Dismantling**  
*Abbruch & Rückbau*



**Mining**  
*Tagebau*



**Piling**  
*Rammen*

# Product Overview

## Produktübersicht



**Max. lift capacity**  
Max. Traglast



**Operating weight appr.**  
Einsatzgewicht ca.



**Max. main boom length**  
Max. Hauptauslegerlänge

**Max. fly jib length**  
Max. Länge Spitzenausleger

**Max. lift capacity luffing jib**  
Max. Traglast Schnabel



**Engine**  
Motor



**Winches**  
Winden

**Rope diameter**  
Seildurchmesser

**Rope speed**  
Seilgeschwindigkeit



**Dimensions**  
Abmessungen

**Min. transport weight appr.**  
Min. Transportgewicht ca.

**Transport width**  
Transportbreite

**Transport height**  
Transporthöhe



**Options\***  
Optionen\*

**613E**

**643E**

**683**

**6113E**

16 t

40 t

80 t

120 t

19.7 t

26 t

65 t

112 t

18.8 m

30 m

42 m

40.2 m

5 m

13 m

16 m

15 m

-

3.5 t

14.4 t

12 t

92 kW

129 kW

186 kW

168 kW

35 kN

35 kN

72 kN

125 kN

14 mm

14 mm

20 mm

26 mm

0-95 m/min

0-95 m/min

0-95 m/min

0-115 m/min

19 t

26 t

45 t

47.7 t

2532 mm

2834 mm

3655 mm

3000 mm

3080 mm

3404 mm

3830 mm

3155 mm

2. Winch, auxiliary jib, fly jib, height-adjustable and tilting cab,  
2. Winde, Spitze, Schnabel, hochfahrbare und neigbare Kabine,



<b>613E</b>	<b>633E</b>	<b>643E</b>	<b>653E</b>	<b>673E</b>	<b>683</b>	<b>6113E</b>
16 t	33 t	40 t	50 t	70 t	80 t	120 t
21.6 t	33 t	40 t	50.2 t	70 t	84 t	112 t
18.8 m	25 m	30 m	30.4 m	36 m	42 m	40.2 m
5 m	13 m	13 m	13 m	15 m	16 m	15 m
-	3.5 t	3.5 t	5 t	5 t	14.4 t	12 t
92 kW	129 kW	129 kW	129 kW	168 kW	186 kW	168 kW
35 kN	35 kN	35 kN	50 kN	50 kN	72 kN	125 kN
14 mm	14 mm	14 mm	16 mm	16 mm	20 mm	26 mm
0-95 m/min	0-95 m/min	0-95 m/min	0-115 m/min	0-115 m/min	0-95 m/min	0-115 m/min

21 t	45 t	36 t	37 t	45 t	50 t	47.7 t
2521 mm	3000 mm	3000 mm	3000 mm	3000 mm	2750 mm	3000 mm
2910 mm	3195 mm	3241 mm	3180 mm	3195 mm	3000 mm	3155 mm

ballast support, 2° / 4° tilting tables, Pick & Carry load charts  
 Ballastablage, 2°/4°-Schräglagentabellen, Pick & Carry Tabellen

**01** Ready to use in 10 minutes  
*Einsatzbereit in 10 Minuten*

**02** Securely lift loads  
*Lasten sicher heben*

**03** Moving loads  
*Lasten bewegen*

**04** Suitable for the toughest terrain  
*Besteht im schwersten Gelände*

**05** Full-Power Boom

**06** Excellent Reliability  
*Hervorragende Zuverlässigkeit*

**07** Individual operator`s place  
*Der individuelle Fahrerplatz*

**08** Compact dimensions  
*Kompakt in den Abmessungen*

**09** Modular design  
*Modularer Aufbau*



**Lift loads ...**

*Höchste Lastaufnahme...*



... lower costs  
... *niedrigste Kosten*



# 01

## Ready to use in 10 minutes

*Einsatzbereit in 10 Minuten*



### » Fast deployment

- **Easy handling:** loading and transport of Telescopic Cranes as a complete machine\*
- **Cheap logistics:** fast and easy loading, easy transport by truck
- **No assembly times:** immediately ready for use after unloading – short jobs on construction sites are thus economical

### » Schnell einsatzbereit

- *Einfaches Handling:* Verladung und Transport der Telekrane als komplette Maschine\*
- *Günstige Logistik:* schnell und einfach verladen, problemlos transportiert mit einem LKW
- *keine Montagezeiten:* nach dem Abladen sofort einsatzbereit - auch kurze Einsätze auf Baustellen sind damit wirtschaftlich

# 02 Securely lift loads even on inclines

## *Lasten sicher heben auch in Schräglage*

### » Flexible working on any terrain

- Always remains capable of working: even works on uneven construction sites in inclined positions using the 2° and 4° load tables\*
- Robust construction: the solid Full-Power Boom also tolerates oblique rope winch
- No leveling: Time savings through flexible working on any terrain

### » Flexibel arbeiten auf jedem Terrain

- Immer arbeitsfähig bleiben: auch auf unebenen Baustellen in Schräglagen mit den 2° und 4° Lasttabellen arbeiten\*
- Robuste Konstruktion: der solide Full-Power Boom verträgt auch schrägen Seilzug bis 4°
- Kein Nivellieren: Zeitersparnis durch flexibles Arbeiten in jedem Gelände



# 03

## Move loads horizontally and vertically

*Lasten horizontal & vertikal bewegen*



### » Pick & Carry with 100% load

- Pick up loads from the truck or storage area and move with the nominal load on the construction site\*
- Full-Power Boom: lift and position the load by telescoping the boom
- No outrigger required, low space requirements due to compact machine\*

### » Pick & Carry mit 100 % Last

- Lasten vom LKW oder Lagerplatz aufnehmen und mit der Nennlast auf der Baustelle verfahren\*
- Full-Power Boom: die Last heben und positionieren durch teleskopieren des Auslegers
- Kein Abstützen erforderlich, wenig Platzbedarf durch kompakte Maschine\*

# 04 Suitable for the toughest terrain

## *Besteht im schwersten Gelände*



### » Max. off-road capabilities & climbing ability\*

- Large contact surfaces of the crawler tracks ensure lower ground contact pressure with high stability
- Powerful crawlers move the crane safely and reliably, even on the toughest terrain and even with a load on the hook
- Extreme climbing ability thanks to high traction forces- safe and reliable up to 36% (20 degrees)\*\*

### » Max. Geländegängigkeit & Steigfähigkeit\*

- Mit großen Aufstandsflächen der Raupenfahrwerke niedriger Bodendruck bei hoher Standsicherheit
- Kräftige Fahrwerke bewegen den Kran auch im schwersten Gelände sicher und zuverlässig - auch mit Last am Haken
- Extreme Steigfähigkeit dank hoher Zugkräfte - sicher und zuverlässig bis 36 % (20 Grad)\*\*

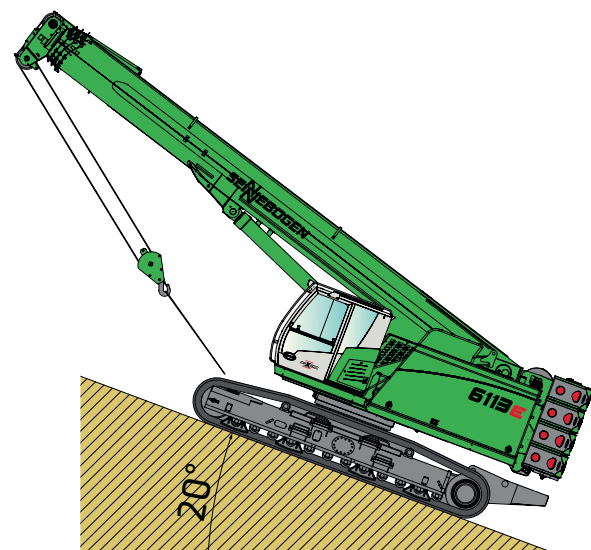

\* Telescopic cranes with crawler chassis\*\* limited for safety reasons, possible technical values are higher

\* Telekrane mit Raupenfahrwerk \*\* limitiert aus Sicherheitsgründen, technisch mögliche Werte liegen höher

# 05 Full-Power Boom for max. flexibility

## *Full-Power Boom für max. Flexibilität*



### » Telescope at any time

- Always possible: telescope rugged boom with nominal load on the hook
- Simple and convenient: Joystick operation for each boom length, without preselection of length or load
- Optimisation: Always the max. load for each boom length

### » Teleskopieren zu jeder Zeit

- Immer möglich: Robusten Ausleger teleskopieren mit Nennlast am Haken
- Einfach und bequem: Per Joystick in jede Auslegerlänge fahren, ohne Längen- und Lastvorwahl
- Optimal: Immer die beste Traglast in jeder Auslegerlänge



Telescope via joystick  
Teleskopieren per Joystick

# 06 Excellent reliability

## *Hervorragende Zuverlässigkeit*

### » Manageable Technology

- Modern engine and drive technology in line with state-of-the-art (level IV)
- Keep it simple: reliable and understandable hydraulics and electrics; avoidance of electronics
- Manageable in service: very good accessibility of all components

### » Beherrschbare Technik

- Moderne Motoren- und Antriebstechnik nach neuestem technischen Stand (Stufe IV)
- Keep it simple: zuverlässige und verständliche Hydraulik und Elektrik; Vermeidung von Elektronik
- Erfahrung im Service: sehr gute Zugänglichkeit zu allen Komponenten



# 07 Individual operator`s place

## *Der individuelle Fahrerplatz*

**MULTI**CAB

**MAX**CAB



### » Comfortable Cabs

- with tilt adjustment and optionally with cab elevation and cabin tilt

### » Komfortable Kabinen

- mit Neigungsverstellung und optional mit Kabinenerhöhung und -neigung



### » SENCON

- current information about the machine status can be obtained with no additional measuring equipment
- Individual fine adjustment, e.g. automatic idling mode
- easy troubleshooting by detailed error description and status information

### » SENCON

- aktuelle Werte können ohne zusätzliche Messgeräte ermittelt werden
- individuelle Möglichkeit der Feinabstimmung, z.B. Leerlaufautomatik
- schnelle Fehlersuche durch detaillierte Fehlerbeschreibung und Meldungen





# 08 Compact dimensions

## *Kompakt in den Abmessungen*



### » At home on tight construction sites

- Very compact construction, ideal for narrow construction sites
- Virtual Wall enables use in security areas
- High stability, low ground pressure, large surface footprints\*

### » Auf engen Baustellen zu Hause

- *Sehr kompakte Konstruktion, ideal für enge Baustellen*
- *Mit Virtual Wall auch in Sicherheitsbereichen einsetzbar*
- *Hohe Standfestigkeit, niedriger Bodendruck, große Aufstandsflächen\**

# 09 Modular design for numerous options\* Modularer Aufbau - vielseitige Lösungen\*

## Equipment Ausrüstungen

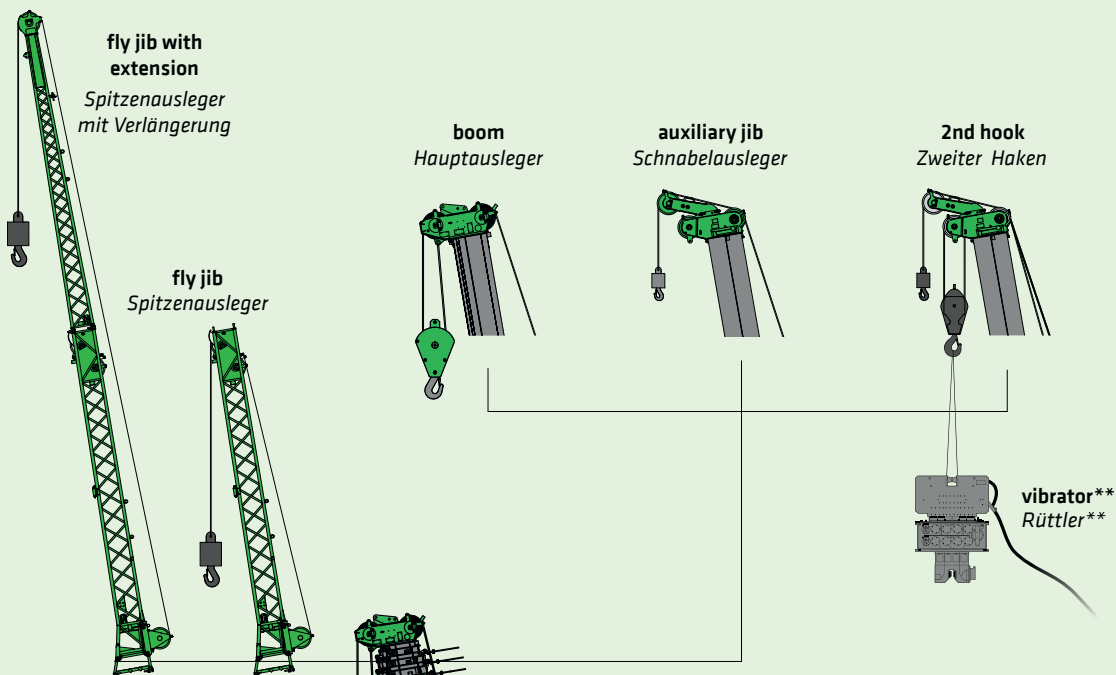

## Cabs Kabinen

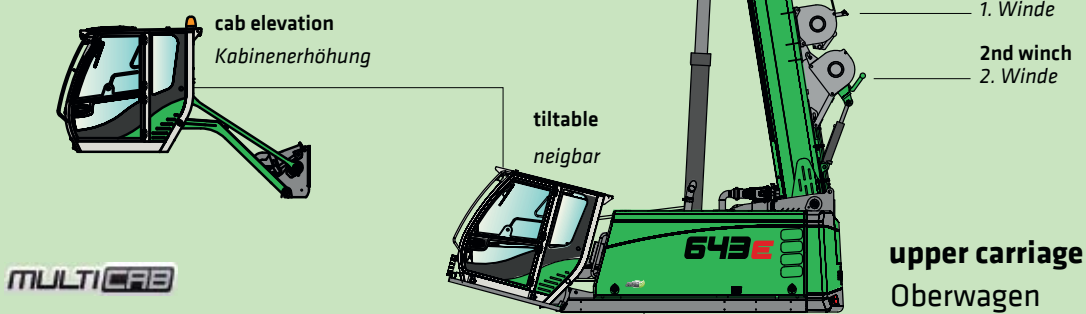

## under carriage Unterwagen

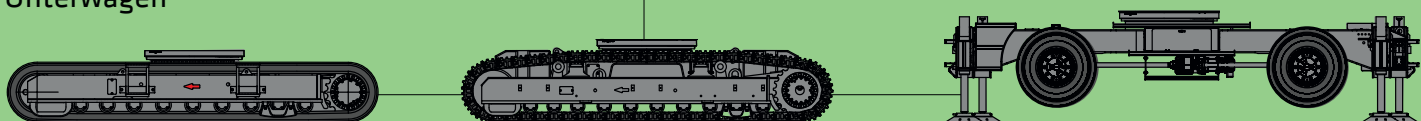

crawler flat base plates  
Raupe Flachbodenplatten

crawler 3-grouser-shoes  
Raupe 3-Stegbodenplatten

mobile version with integrated 4-point-pedestal  
Mobil mit integrierter 4-Punkt-Abstützung

\* Illustrated for Telescopic Crane 643 \*\* not included in the SENNEBOGEN scope of delivery  
\* Beispielhaft ausgeführt für Telekran Typ 643 \*\* kein SENNEBOGEN Lieferumfang

# 613E Telescopic Mobile Crane

Mobil-Teleskopkran

 **16 t**

 **18,8 m / 14,6 m\***

 **19,7 t**

 **MULTICAB**  
elevating comfort cab  
hochfahrbare Komfortkabine

 **2,55 m** transport width  
Transportbreite

 **3** steering modes  
Lenkungsarten



## Options Optionen

- fly jib SA 5.0 m
- working platform 350 kg, 360°
- clamshell equipment
- fork lift 18.8 m / 2.5 t, 14.6 m / 3 t
- radio remote control

- Spitzenausleger SA 5,0 m
- Arbeitsplattform 350 kg, 360°
- Greiferausrüstung
- Hubgabel 18,8 m / 2,5 t, 14,6 m / 3 t
- Funkfernbedienung

**4.3 m**  
eye level *Sichthöhe*

**2.55 m**  
transport width  
*Transportbreite*

# Unique worldwide:

Mobile & compact telescopic crane with 16 load capacity

*Einzigartig weltweit:*

*Mobiler, kompakter Telekran mit 16 Traglast*



**613 M - flexible construction site crane with remote control in construction; Germany**

*613 M - flexibler Baustellenkran mit Fernbedienung im Bauwesen; Deutschland*



**613 M - flexible 16 t construction site crane with overview due to elevating cab; Germany**

*613 M - flexibler 16 t Baustellenkran mit Übersicht dank hochfahrender Kabine; Deutschland*



613 M – as auxiliary crane with remote control in bridge construction; Germany  
613 M – als Hilfskran mit Fernsteuerung im Brückenbau; Deutschland



613 M – lift and move loads with folding fly jib, pick & carry; Germany  
613 M – mit Klappspitze Lasten heben und verfahren, Pick & Carry; Deutschland



**613 M – as an industrial crane for assembly and storage tasks; Spain**  
*613 M – als Industriekran für Montage- und Lagerplatzaufgaben; Spanien*



**613 M – construction crane for all lifting tasks with elevating and tiltable cab; Germany**  
*613 M – Baustellenkran für alle Hebeaufgaben mit hochfahrbarer und neigbarer Kabine; Deutschland*



613 M – Swiss Alps  
613 M – Schweizer Alpen



613 M – at home on narrow construction sites; Germany  
613 M – auf engsten Baustellen zu Hause; Deutschland



613 M – even flexible in places that are difficult to access; Germany  
613 M – auch an schlecht zugänglichen Stellen flexibel einsetzbar; Deutschland





**613 M – clamshell operation in hydraulic engineering; Germany**  
*613 M – Zweischalengreifereinsatz im Wasserbau; Deutschland*



**613 M – compact construction site crane with the best overview in civil engineering; France**  
*613 M – kompakter Baustellenkran mit bester Übersicht im Tiefbau; Frankreich*

# 643E

## Telescopic Mobile Crane Mobil-Teleskopkran

 **40 t**

 **30 m / 13 m**

 **27 t\***

 **MULTICAB**  
elevating comfort cab  
hochfahrbare Komfortkabine

 **2,84 m** transport width  
Transportbreite

## Options Optionen

- 3,5 t auxiliary jib
- 13 m fly jib 0° / 40°
- single tires 4 x 14.00 - 24
- 2. crane winch 35 kN
- radio remote control
- working area limitation

- 3,5 t Schnabelausleger
- 13 m Spitzenausleger 0° / 40°
- Singlebereifung 4 x 14.00 - 24
- 2. Kranwinde 35 kN
- Funkfernsteuerung
- Arbeitsbereichsbegrenzung



# Mobile Multitalent:

for various industry applications & jobsites

*Mobiles Multitalent*  
für unterschiedliche Industrie- & Baustelleneinsätze



643 M - Pick & Carry with seawater branding of the Waterway Authority; Germany  
643 M - Pick & Carry mit Seewasserzeichen des Wasserschiffahrtsamtes; Deutschland



643 M - industrial version for heavy pick & carry tasks; Germany  
643 M - Industrierausführung für schwere Pick & Carry Aufgaben; Deutschland



643 M – lifting heavy concrete-prefabricated parts; Germany  
 643 M – Heben von schweren Betonfertigteilen; Deutschland



643 M & 613 M - use on bridge construction sites; Germany  
 643 M & 613 M – Einsatz auf Brückenbaustellen; Deutschland



**643 M - pipe installation works at civil engineerings; Germany**  
*643 M - Rohrverlegung im Tiefbau; Deutschland*



**643 M - quick to transport by simple self-loading using a ramp**  
*643 M - schnell transportfähig über einfache Selbstverladung über Rampe*





**643 M - lifting tasks with vertical cab adjustment; Luxembourg**  
*643 M - Hebeaufgaben mit vertikaler Kabinenverstellung; Luxemburg*



**643 M - lifting tasks on construction site with vertical cab adjustment; Germany**  
*643 M - Hebeaufgabe im Tiefbau mit vertikaler Kabinenverstellung; Deutschland*

# 683

## Telescopic Mobile Crane *Mobil-Teleskopkran*

 **80 t**

 **MAX CAB** elevating comfort cab  
*hochfahrbare Komfortkabine*

 **42 m + 10 m / 16 m** fly jib  
*Spitzenausleger*

 **3 m** transport width  
*Transportbreite*

 **65 t\***



### Options Optionen

- fly jib, 10 m + 16 m, 0°/20°/40° tilt possible
- 14.4 t auxiliary jib
- radio remote control

- 10 m und 16 m Spitzenausleger, 0°/20°/40° neigbar
- 14,4 t Schnabelausleger
- Funkfernsteuerung





**683 M - hoisting works of concrete-prefabricated parts in building industrial works; Germany**  
*683 M - Fertigbetontteile in Industrie- und Hallenbau sicher heben; Deutschland*



**683 M - direct view of the load thanks to the elevating cab; Germany**  
*683 M - direkte Sicht auf die Last dank hochfahrbarer Kabine; Deutschland*



**683 M - use as storage yard crane; Germany**  
*683 M - Einsatz als Lagerplatzkran; Deutschland*



**683 M - operation with radio remote control; Germany**  
*683 M - Bedienung mit Funkfernsteuerung; Deutschland*



**683 M - move heavy loads safely with Pick & Carry; Germany**  
*683 M - Schwere Lasten mit Pick & Carry sicher verfahren; Deutschland*



**683 M - robust construction for all lifting tasks; Germany**  
*683 M - robuste Bauweise für alle Hebeaufgaben; Deutschland*

# 6113E Telescopic Mobile Crane

Mobil-Teleskopkran

 **80 t**

 **MAX CAB** elevating comfort cab  
hochfahrbare Komfortkabine

 **42 m + 10 m/ 16 m** fly jib  
Spitzenausleger

 **3 m** transport width  
Transportbreite

 **65 t\***



## Options Optionen

- fly jib, 10 m + 16 m, 0°/20°/40° tiltable
- 14,4 t auxiliary jib
- radio remote control

- 10 m und 16 m Spitzenausleger, 0°/20°/40° neigbar
- 14,4 t Schnabelausleger
- Funkfernsteuerung



» Pick & Carry

max.  
32 t  
bei at 5,5 m

# 613E Telescopic Crawler Crane

Raupen-Teleskopkran

 **16 t**

 **18,8 m / 14,6 m\***

 **24,3 t**

 **MULTICAB**  
elevating comfort cab  
hochfahrbare Komfortkabine

**2,55 m**  
transport width  
Transportbreite

» **advantage: Transport**  
possible without permit

» **Vorteil: Transport**  
ohne Genehmigung möglich

## Options Optionen

- fly jib SA 5.0 m
- working platform 350 kg, 360°
- clamshell equipment
- fork lift 18.8 m / 2.5 t, 14.6 m / 3 t
- radio remote control

- Spitzenausleger SA 5,0 m
- Arbeitsplattform 350 kg, 360°
- Greiferausrüstung
- Hubgabel 18,8 m / 2,5 t, 14,6 m / 3 t
- Funkfernbedienung

**4.3 m**  
eye level *Sichthöhe*





**613 R - maximum safety when lifting loads in infrastructure construction thanks to the elevating cab; Germany**  
*613 R - maximale Sicherheit beim Heben von Lasten im Infrastrukturbau dank hochfahrbarer Kabine; Deutschland*



**613 R - safely position loads on poorly accessible construction sites; Germany**  
*613 R - Lasten sicher positionieren auf schlecht zugänglichen Baustellen; Deutschland*



**613 R - tried and tested flexible operation with radio remote control from the outset; Germany**  
*613 R - seit den Anfängen bewährt, flexible Bedienung mit Funk-Fernsteuerung; Deutschland*



**613 R - work under load, even in inclined position, increases flexibility on every construction site; Germany**  
*613 R - verfahren unter Last auch in Schrägstellung erhöht die Flexibilität auf jeder Baustelle; Deutschland*





## » Pick & Carry

**613 R - lifting and moving heavy components in civil engineering; Germany**  
*613 R - heben und verfahren schwerer Bauteile im Hoch- und Tiefbau; Deutschland*



613 R - lifting tasks in confined spaces on urban construction sites; Singapore  
613 R - Hebearbeiten auf engem Raum auf städtischen Baustellen; Singapur



613 R - assembly in industrial and structural engineering; France  
613 R - Montage im Industrie- und Hochbau; Frankreich

< 2,55 m

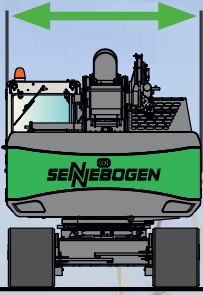

## Easy transport *Einfacher Transport*



613 R - simple and quick loading and transport without the need for a permit; Germany

613 R - einfach und schnell verladen und ohne Genehmigungspflicht transportieren; Deutschland



613 R - heavy lifting and moving, even on narrow subway construction sites; German

613 R - schweres heben und bewegen auch auf engen U-Bahn Baustellen; Deutschland

# 633E Telescopic Crawler Crane

## Raupen-Teleskopkran

 **33 t**

 **25,2 m / 13 m\***

 **33 t**

 **MULTICAB**  
elevating comfort cab  
*hochfahrbare Komfortkabine*

 **3 m** transport width  
*Transportbreite*

## Options Optionen

- fly jib 6.5 m/0°/40°
- extended fly boom at 13 m
- 3.5 t auxiliary jib
- 2. crane winch 35 kN
- load tables 2° / 4° inclined position
- remote radio control

- Spitzenausleger 6,5m/0°/40°
- Verlängerter Spitzenausleger auf 13 m
- 3,5 t Schnabelausleger
- 2. Kranwinde 35 kN
- Lasttabellen 2°/4° Schräglage
- Funkfernsteuerung





633 R - hoisting crane on difficult terrain in bridge construction; Kosovo  
633 R - Hebekran auf schwierigem Untergrund im Brückenbau; Kosovo

## Transport with a 3-axle trailer *Mit 3-Achsanhänger transportieren*



633 R - completely loaded and ready for transport, ready for use in minutes; Germany  
633 R - komplett verladen und transportbereit, in Minuten einsatzbereit; Deutschland

# 643E

## Telescopic Crawler Crane Raupen-Teleskopkran



**40 t**



**3 m**

transport width at 700 mm crawler shoes  
Transportbreite bei 700 mm Bodenplatten



**30 m / 13 m**



**27 t\***



**MULTICAB**

elevating comfort cab  
hochfahrbare Komfortkabine

## Options Optionen

- capacity loads with 2° / 4° tilted position
- 700 mm / 800 mm / 900 mm base plates
- 3.5 t auxiliary jib
- 13 m fly jib 0° / 40°
- single tires 4 x 14.00 - 24
- 2. crane winch 35 kN
- radio remote control
- working area limitation

- Lasttabellen mit 2° / 4° Schräglage
- 700 mm / 800 mm / 900 mm Bodenplatten
- 3,5 t Schnabelausleger
- 13 m Spitzenausleger 0° / 40°
- Singlebereifung 4 x 14.00 - 24
- 2. Kranwinde 35 kN
- Funkfernsteuerung
- Arbeitsbereichsbegrenzung





**643 R - use in low-temperature as a service crane; Antarctic**  
*643 R - im Tieftemperatureinsatz als Service-Kran; Antarktis*



**643 R - reliability in operation counts when no service partner is nearby; Antarctic**  
*643 R - Zuverlässigkeit im Einsatz zählt, wenn kein Service-Partner in der Nähe ist; Antarktis*



643 R - drive loads and telescoping work; UK  
 643 R - Lasten fahren und teleskopieren; UK



643 R - operating in a compact space with compact dimensions; Germany  
 643 R - mit kompakten Abmessungen auf engem Raum operieren; Deutschland





**643 R - reliable even in tandem lift; Germany**  
*643 R - zuverlässig auch im Tandemhub; Deutschland*



**643 R - lifting, driving and positioning loads; Germany**  
*643 R - Lasten anheben, fahren und positionieren; Deutschland*



**643 R - hydraulic engineering on a barge; Australia**  
*643 R - Wasserbau auf Ponton; Australien*



**643 R - with elevating cab, also used during transshipment in the port; Netherlands**  
*643 R - mit hochfahrbarer Kabine auch im Umschlag im Hafen; Niederlande*



**643 R - heavy loads on difficult terrain; Germany**  
*643 R - Verfahren mit Last auf schwierigem Terrain; Deutschland*



**643 R - flexibility at civil engineering; Germany**  
*643 R - Flexibilität im Tiefbau; Deutschland*

# 653E Telescopic Crawler Crane

## Raupen-Teleskopkran

 **50 t**

 **30,4 m / 6,5 m**

 **50,2 t\* / 44,7 t\*\***

 **MAX CAB** **comfort cab, 15° tiltable**  
*Komfortkabine, 15° neigbar*

 **TRANSPORT** **3 m** **transport width**  
*Transportbreite*

## Options Optionen

- 13 m fly jib 0° / 40°
- 5 t auxiliary jib
- 2. crane winch 50 kN
- load capacities for 2° / 4° incline position
- 700 mm / 800 mm / 900 mm base plates
- ballast support

- 13 m Spitzenausleger 0° / 40°
- 5 t Schnabelausleger
- 2. Kranwinde 50 kN
- Lasttabellen für 2° / 4° Schrägstellung
- 700 / 800 / 900 mm Bodenplatten
- Ballastablage





**653 R - Pick & Carry with loads on the construction site; Germany**  
*653 R - Pick & Carry mit Lasten auf der Baustelle verfahren; Deutschland*



**653 R - Civil and underground engineering at an airport; France**  
*653 R - Tiefbauarbeiten auf dem Flughafengelände; Frankreich*





653 R - lift sheet piles safely and reliably with vibrator and bring them into the ground; Germany  
653 R - mit Rüttler Spundwände sicher und zuverlässig heben und einbringen in den Boden; Deutschland







**653 R - compact and completely loaded and transported; UK**  
*653 R - kompakt und komplett verladen und transportiert; UK*



**653 R - with aerial work platform, 4 m width max., availability on request, project-based**  
*653 R - mit Hubarbeitsbühne, 4 m Breite max., Verfügbarkeit auf Anfrage, projektbasiert*

# 673E Telescopic Crawler Crane

## Raupen-Teleskopkran

 **70 t**

 **36 m**

 **69,8 t\***

 **MAX CAB** comfort cab, 20° tiltable  
Komfortkabine, 20° neigbar

**TRANSPORT** **3 m** transport width  
Transportbreite

**TRANSPORT** **45,5 t\*\*** transport weight  
Transportgewicht



## Options Optionen

- 8 m fly jib, 10 t load capacity, 0° / 20° / 40° tiltable
- fly jib extension to 15 m, 5 t load capacity
- 5 t auxiliary jib
- 2. crane winch 50 kN
- load capacities for 2° / 4° incline position
- 700 mm / 800 mm / 900 mm base plates
- radio remote control

- 8 m Spitzenausleger, 10 t Tragfähigkeit, 0° / 20° / 40° neigbar
- Spitzenauslegerverlängerung auf 15 m, 5 t Tragfähigkeit
- 5 t Schnabelausleger
- 2. Kranwinde 50 kN
- Lasttabellen für 2° / 4° Schrägstellung
- 700 / 800 / 900 mm Bodenplatten
- Funkfernsteuerung



1

673 R - position and lift loads...  
673 R - Lasten heben und positionieren...



2

... and use the vibrohammer to bring it back to the ground; Germany  
... und mit Rüttler in den Boden einbringen; Deutschland





**673 R - working safely, even in an inclined position using agitator; Germany**  
*673 R - sicher Arbeiten auch in Schräglage mit Rüttler; Deutschland*



**673 R - components of trucks unloaded and transported; Switzerland**  
*673 R - Komponenten von LKW entladen und verfahren; Schweiz*





**673 R - reliable for use on construction sites with difficult terrain conditions; UK**  
*673 R - zuverlässig auf Baustellen mit schwierigen Bodenbeschaffenheiten; UK*



**673 R - lifting loads safely, especially in hard-to-reach places; France**  
*673 R - gerade in schwer zugänglichen Plätzen Lasten sicher heben; Frankreich*

# 683

## Telescopic Crawler Crane

Raupen-Teleskopkran



80 t



42 m + 10 m / 16 m fly jib  
Spitzenausleger



65 t\*



**MAX CAB** comfort cab, adjustable  
Komfortkabine, verstellbar



3 m transport width  
Transportbreite

Full-Power Boom

## Options Optionen

- 10 m and 16 m fly jib,  
0° / 20° / 40° tiltable
- 14.4 t auxiliary jib

- 10 m und 16 m Spitzenausleger,  
0° / 20° / 40° neigbar
- 14,4 t Schnabelausleger







**683 R – reliable construction site crane**  
 683 R – zuverlässiger Baustellenkran



**683 R – infrastructure pre-fab concrete parts, pick & carry operation; Philippines**  
 683 R - Infrastruktur Betonfertigteile; pick & carry; Philippinen



**683 R - safety on narrow urban construction sites, with fast telescoping wind outriggers, no depositing; Singapore**  
*683 R - Sicherheit auf engen Stadtbaustellen, bei Wind Ausleger schnell einteleskopiert, kein Ablegen; Singapur*



**683 R - open-pit service crane on difficult terrain**  
*683 R - Service-Kran im Tagebau auf schwierigem Boden*



683 R - at foundation engineering with drill leader; Singapore  
683 R - im Spezialtiefbau mit Bohrmäkler; Singapur



**683 R - lifting, moving and positioning precast concrete elements; Netherlands**  
*683 R - Betonfertigteile heben, verfahren und positionieren; Niederlande*



**683 R - reliable dismantling applications; Germany**  
*683 R - zuverlässig auch im Rückbau im Einsatz; Deutschland*



**683 R - installation of large pipe thanks to Pick & Carry**  
*683 R - Pipelinebau dank Pick & Carry Einsatz*

# 6113E Telescopic Crawler Crane

## Raupen-Teleskopkran



120 t



40,2 m + 8 m / 15 m fly jib  
Spitzenausleger



84,3 t\*



**MAX CAB** comfort cab, 20° tiltable  
Komfortkabine, 20° neigbar



**TRANSPORT** 3 m\*\* transport width  
Transportbreite



**TRANSPORT** 47,7 t\*\* transport weight  
Transportgewicht



## Options Optionen

- 8 m and 15 m fly jib, 0° / 20° / 40° tiltable
- auxiliary jib 12 t
- 2. crane winch 125 kW
- load table 2° / 4°
- 900 mm flat base plate

- 8 m und 15 m Spitzenausleger, 0° / 20° / 40° neigbar
- Schnabelausleger 12 t
- 2. Kranwinde 125 kW
- Lasttabelle 2° / 4°
- 900 mm Flachbodenplatter



**6113 R - in use on large construction sites in various lifting applications; Dubai**  
*6113 R - auf Großbaustellen in diversen Hebeeinsätzen im Einsatz; Dubai*



**6113 R - secure positioning and setting of concrete piers, even with large working radii**  
*6113 R - Betonpfeiler auch bei großen Arbeitsradien sicher positionieren und setzen*



**6113 R - moving and positioning large and heavy components in civil engineering; Germany**  
*6113 R - große und schwere Komponenten verfahren und positionieren im Tiefbau; Deutschland*



**6113 R - used on ships as a service crane, even when on inclinations; Netherlands**  
*6113 R - auf Schiffen als Servicekran auch bei Schrägstellung arbeiten; Niederlande*





6113 R - truck loading and unloading with precast concrete parts; Singapore  
6113 R - LKW Be- und Entladung mit Beton-Fertigteilen; Singapur



**6113 R - service crane operations for heavy duty foundation jobsite; Paris**  
*6113 R - Einsatz als Servicekran für Schwerlast-Einsatz; Paris*



**6113 R - high stability on any site surface with Star-Lifter broad gauge chassis; Germany**  
*6113 R - hohe Standfestigkeit auf jedem Baustellenuntergrund mit Star-Lifter Breitspurunterwagen; Deutschland*



6113 R - used as a flexible service crane in wind energy; Germany  
6113 R - im Einsatz als flexibler Service-Kran in der Windenergie; Deutschland

# Customized solutions - Special applications

## *Kunden-/ Sonderlösungen*

» **SENNEBOGEN** has been designing customer-specific solutions for decades, e.g.:

- Use with agitator & Powerpack
- Adaption to rail undercarriages
- Use with drill broker or leader
- Is your individual requirement our next project?

» **SENNEBOGEN** realisiert seit Jahrzehnten kundenspezifische Lösungen, z.B.:

- Einsatz mit Rüttler & Powerpack
- Adaption auf Schienenunterwagen
- Einsatz mit Bohrmäkler oder Ramme
- Ist Ihre individuelle Anforderung das nächste Projekt?





6113 - with rail undercarriage ; Tahiti  
 6113 - mit Schienenunterwagen; Tahiti



630 R - use with drill leader  
 630 R - Einsatz mit Bohrmäkler



683 R TP - use with leader  
 683 R TP - Einsatz mit Ramme



608 M - slope stabilization with drill carriage and rail boogies; Germany  
608 M - Hangsicherung mit Bohrlafette und Schienen-Boogies; Deutschland





**Rail Cranes from SENNEBOGEN  
and DEMATEC Rail BV are designed  
according to the following standards**

*Schienenkrane von SENNEBOGEN  
und DEMATEC Rail BV nach  
folgenden Standards*

- Europe / Europa EN 157461
- United Kingdom RIS 1530PLTISUE6
- Germany / Deutschland RIL 931 (2017)
- Australia / Australien ESR 001 ROLLING STOCK



# The SENNEBOGEN Academy

## Die SENNEBOGEN Akademie

### Training creates knowledge

- In our group courses we train up to 12 persons from basic level up to SENNEBOGEN product experts
- Optimal learning success for our dealers, service partners and operators, who learn how they can service and repair our machines
- Machines, test and simulation installation enrich the theoretical content of each training with practical exercises
- On our demonstration site we operate our machines under real working conditions - working machines guaranteed

### Ausbildung schafft Wissensvorsprung

- In unseren Kursen bilden wir vom Basis-Training bis zum Produkt-Experten in Gruppen bis 12 Personen aus
- Optimaler Lernerfolg für unsere Händler und Kunden, die durch das Training unsere Maschinen sicher warten und instand setzen können
- Diverse Maschinen, Test- und Simulationsstände ergänzen die theoretischen Schulungsinhalte mit intensiven praktischen Übungen
- Auf dem Vorführgelände fahren wir unsere Maschinen unter absolut echten Einsatzbedingungen - Serienreife garantiert

### Training - an ideal foundation for best machine performance

Schulung - Die ideale Basis, um die Leistungsfähigkeit der Maschine zu nutzen





# SENtrack telematics system

## SENtrack Telematiksystem

Further information is available in our brochure SENtrack telematics system.

Weitere Informationen finden Sie in unserer Broschüre SENtrack Telematiksystem.



The SENtrack telematics system consists of a network module and communicates with the telematics system database via a cellular network. With your login and password you gain access to your data in the telematics system database.

Das SENtrack Telematiksystem besteht aus einem vernetzten Kommunikationsmodul und kommuniziert via Mobilfunknetz mit der Telematik-Datenbank. Mit Login und Passwort haben Sie Zugriff auf Ihre Daten in der Telematik-Datenbank.

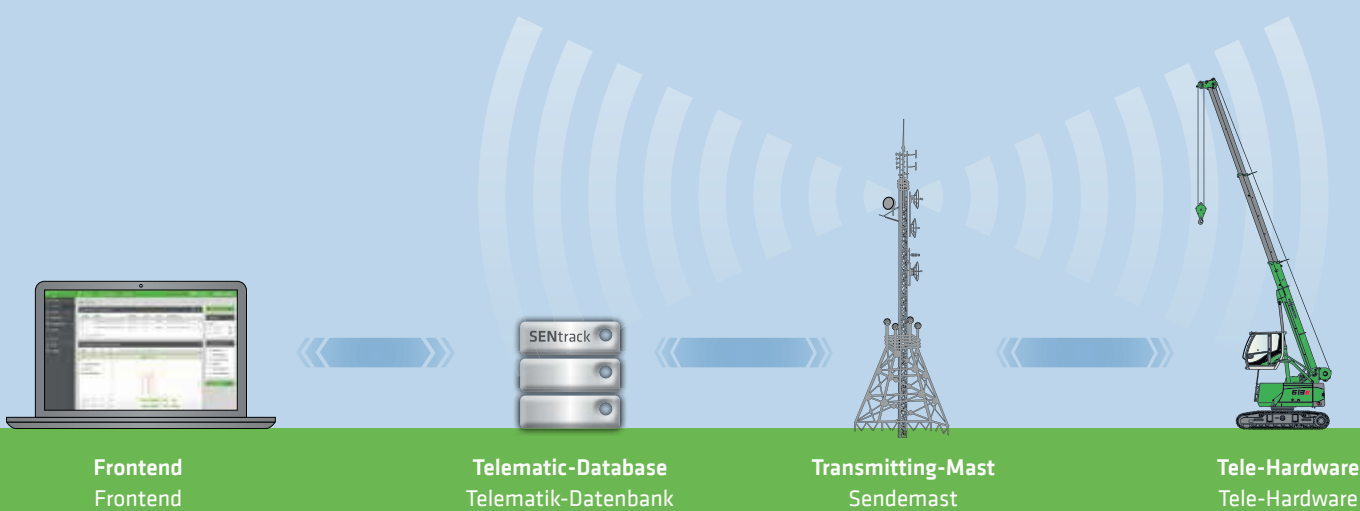

### » You reduce your service costs

- key operating parameters allow you to keep an eye on your machines in their optimum operating state at all times
- as you can arrange maintenance or a service as a precaution if the operating parameters deviate significantly from the set value

### » You improve your productivity

- identify and optimize resource
- assign the right machine to the right application
- optimize your site

### » You reduce fuel consumption

- identify and reduce the machines' idle times

### » You safeguard your investment

- alarms keep you informed about critical states
- deactivate the machine remotely in the event of irregular movements

### » Sie senken die Service-Kosten

- Maschinen in ihrem optimalen Betriebszustand jederzeit im Blick haben
- prophylaktisch eine Wartung oder einen Service veranlassen können, wenn die Betriebsparameter signifikant vom Sollwert abweichen

### » Sie verbessern Ihre Produktivität

- Auslastung der Maschinen erkennen und optimieren
- die richtige Maschine dem richtigen Einsatz zuordnen
- Fahrstrecken analysieren und optimieren

### » Sie senken die Verbrauchswerte

- Leerlaufzeiten der Maschinen erkennen und reduzieren

### » Sie sichern Ihre Investition ab

- Alarmmeldungen über kritische Zustände
- Maschine bei irregulären Bewegungen zentral deaktivieren

# Worldwide Customer Orientation

## *Weltweite Kundenorientierung*

- More than 120 sales partner worldwide
- More than 300 service stations
- Own subsidiaries and representative offices in most important key regions
- Three individually specialized production plants in Germany
- Renowned suppliers deliver first-class key components

- Mehr als 120 Vertriebspartner weltweit
- Mehr als 300 Servicestützpunkte
- Eigene Tochtergesellschaften und Vertretungen in den wichtigsten Schlüsselregionen
- Drei individuell ausgerichtete Produktionsstandorte in Deutschland
- Namhafte Lieferanten, hochwertige Schlüsselkomponenten



Constantino Lannes

SENNEBOGEN LLC, Stanley/N.C.  
SENNEBOGEN LLC, Stanley/N.C.

1957 Sennebogen Trail  
Stanley, North Carolina 28164  
Phone +704 347-4910  
Fax +704 347-8894  
sales@sennebogenllc.com





Bernhard Kraus

**SENNEBOGEN Maschinenfabrik GmbH/Germany**  
*SENNEBOGEN Maschinenfabrik GmbH/Deutschland*

Sennebogenstraße 10  
94315 Straubing – Germany  
Phone +49 9421 540 143  
Fax +49 9421 540 340  
bernhard.kraus@sennebogen.de

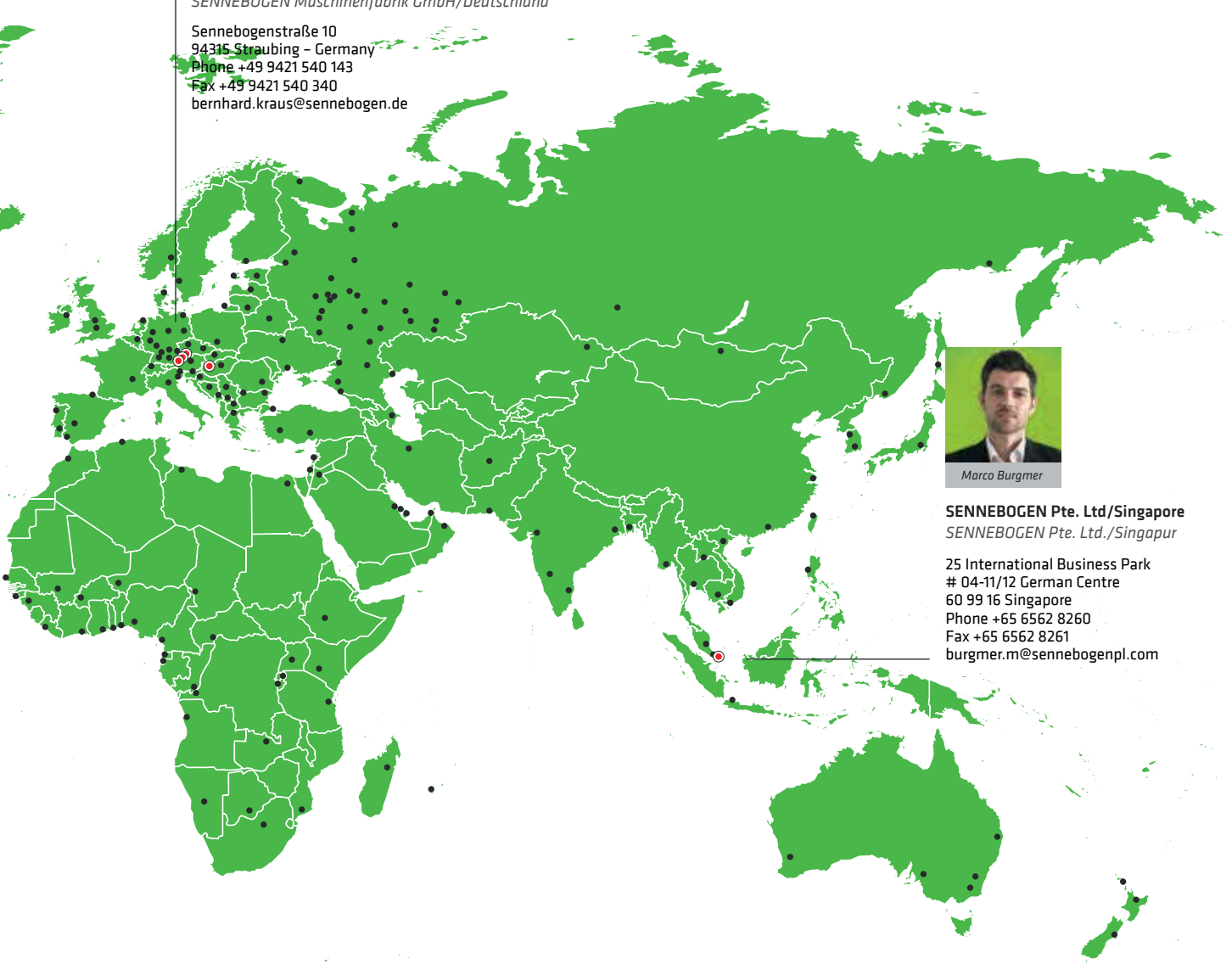

Marco Burgmer

**SENNEBOGEN Pte. Ltd./Singapore**  
*SENNEBOGEN Pte. Ltd./Singapur*

25 International Business Park  
# 04-11/12 German Centre  
60 99 16 Singapore  
Phone +65 6562 8260  
Fax +65 6562 8261  
burgmer.m@sennebogenpl.com

**1 Works 1 in Straubing**  
*Werk 1 in Straubing*

**2 Works 2 in Straubing**  
*Werk 2 in Straubing*

**3 Works Wackersdorf**  
*Werk Wackersdorf*

**4 Works Balantonfüred/Hungary**  
*Werk Balantonfüred/Ungarn*



**Spare Parts Center with more than 20.000 different spare and wear parts**  
*Ersatzteilzentrum mit mehr als 20.000 verschiedenen Verschleiß- und Ersatzteilen*

Heavy Duty  
Schwerlast

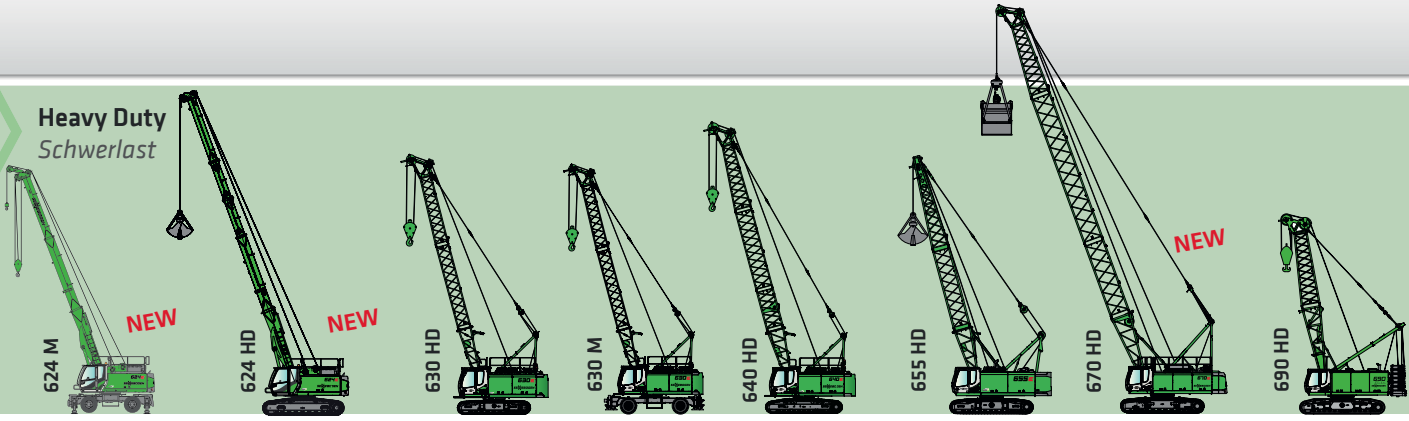

13,5 t	13,5 t	30 t	30 t	40 t	55 t	70 t	90 t
129 kW	129 kW	186 kW	186 kW	186 kW	261 kW	261 kW	447 kW
2 x 60 kN	2 x 60 kN	2 x 120 kN	2 x 120 kN	2 x 120 kN	2 x 160 kN	2 x 160 kN	2 x 250 kN



16 t	16 t	16 t	33 t	40 t	40 t	50 t	70 t	80 t	80 t	120 t	120 t
24 m	24 m	24 m	38 m	43 m	43 m	43 m	51 m	58 m	58 m	67 m	67 m
92 kW	92 kW	92 kW	129 kW	129 kW	129 kW	129 kW	168 kW	186 kW	186 kW	168 kW	168 kW

# Productline Produktübersicht

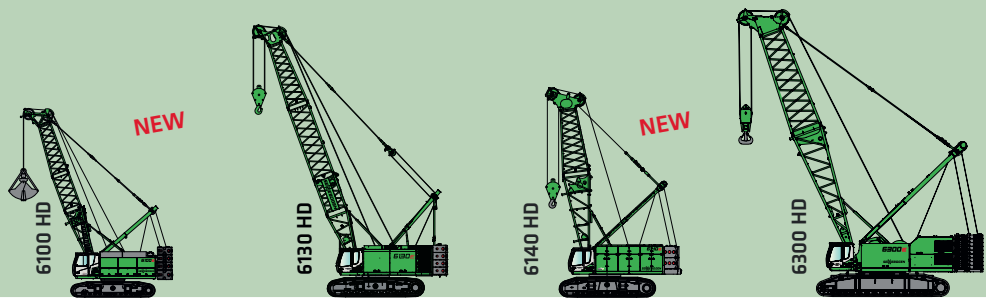

- |            |              |              |                    |
|------------|--------------|--------------|--------------------|
| 100 t      | 130 t        | 140 t        | 300 t              |
| 451 kW     | 570 / 708 kW | 570 / 708 kW | 570 / 708 / 840 kW |
| 2 x 200 kN | 2 x 250 kN   | 2 x 300 kN   | 2 x 350 kN         |
| 2 x 250 kN | 2 x 300 kN   | 2 x 350 kN   | 2 x 450 kN         |
| 2 x 275 kN | 2 x 350 kN   |              |                    |
| 2 x 300 kN |              |              |                    |



Crawler Cranes  
Raupenkrane

- |        |        |        |        |        |
|--------|--------|--------|--------|--------|
| 50 t   | 80 t   | 125 t  | 180 t  | 300 t  |
| 129 kW | 186 kW | 186 kW | 261 kW | 313 kW |

# SENNEBOGEN Telescopic Cranes - Flexibility & Mobility on the highest level

*SENNEBOGEN Teleskopkrane -  
Flexibilität & Mobilität auf höchstem Niveau*







**SENNEBOGEN**  
Maschinenfabrik GmbH  
Hebbelstraße 30  
94315 Straubing, Germany  
Tel. +49 94 21 540-0  
Fax +49 94 21 43882  
marketing@sennebogen.de  
www.sennebogen.com

**SENNEBOGEN Pte. Ltd.**  
25 International Business Park  
# 03-70/71 German Centre  
Singapore 60 99 16  
Tel. +65 6562 826-0  
Fax +65 6562 826-1  
info@sennebogen.asia  
www.sennebogen.asia

**Detailed product brochures on request:**

**The technical data and charts included in this brochure are for general information only. No responsibility is taken for the correctness of the details provided. This information is subject to technical modifications, changes in equipment and enhancements. The pictures may include optional equipment.**

*Fragen Sie bitte nach detaillierten Produktbroschüren:*

*Die Daten und Übersichtstabellen dieser Broschüre dienen nur zur allgemeinen Information. Alle Angaben sind ohne Gewähr. Technische Änderungen, Ausstattungsänderungen und Weiterentwicklungen vorbehalten. Geräteabbildungen können Sonder- und Zusatzausstattungen enthalten.*